

**2006-2007 ESTIMATED
ACTUALS
and
2007-2008 ALL FUNDS
BUDGET**



TABLE OF CONTENTS

- I General Fund Overview**
- II Criteria and Assumptions**
- III General Fund**
- IV Other Funds**
- V Criteria and Standards**
- VI Glossary of Common
 School Finance Terms**
- VII Notes**

I General Fund Overview

General Fund Revenues, 2007-08

General Fund Revenues, 2007-08

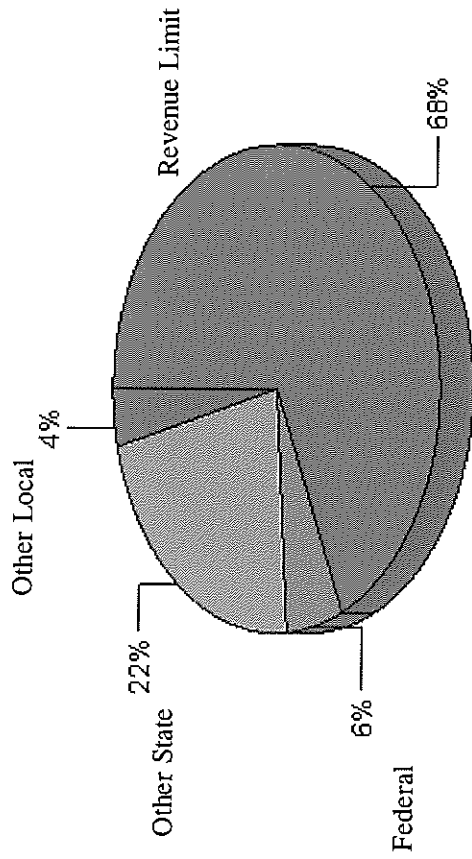

68% of the District's revenues are generated from the District's Revenue Limit

Most of the District's General Fund revenue is generated from the District's Revenue Limit, which yields funds based on a state-determined dollar amount multiplied by the average number of students who are in attendance throughout the school year. Public education--unlike any other public agency--receives most of its revenue based on the population it serves.

The second biggest source of revenue is state categorical income that must be spent for selected state-determined programs. The two largest categorical programs are Special Education services, a restricted program, and K-3 Class-Size Reduction, an unrestricted program.

Federal income is a small portion of the entire District income. Again, most of the federal income is restricted since it must be expended for purposes that are determined by the grantor, not the local Board of Education.

The District's total available resources in the budget year include a "beginning balance," which reflects an unexpended carryover balance from the prior fiscal year.

General Fund Sources (In Million)

Revenue Limit	\$161.0
Federal	13.1
Other State	52.2
Other Local	8.9
Total Revenues	235.3
Beginning Balance	25.1
Total General Fund	\$260.4

Reflects information as of June 2007

General Fund Expenditures, 2007-08

It takes people to teach students and 83% of the District's total expenditures are committed to the employees of the District

Most of the expenditures of the District are committed to the salaries and benefits for employees of the District. It takes people to teach students, and in ORANGE UNIFIED SCHOOL DISTRICT, 83% of the District's budgeted expenditures are for the services of District employees.

Employee salaries are divided into three separate line items--certificated, management, and classified employees. Certificated employees include teachers, counselors, nurses, librarians, psychologists, and others who provide services that require credentials from the state of California. Management employees include principals, vice principals, instructional leaders, classified management personnel, and district superintendents.

General Fund Expenditures, 2007-08

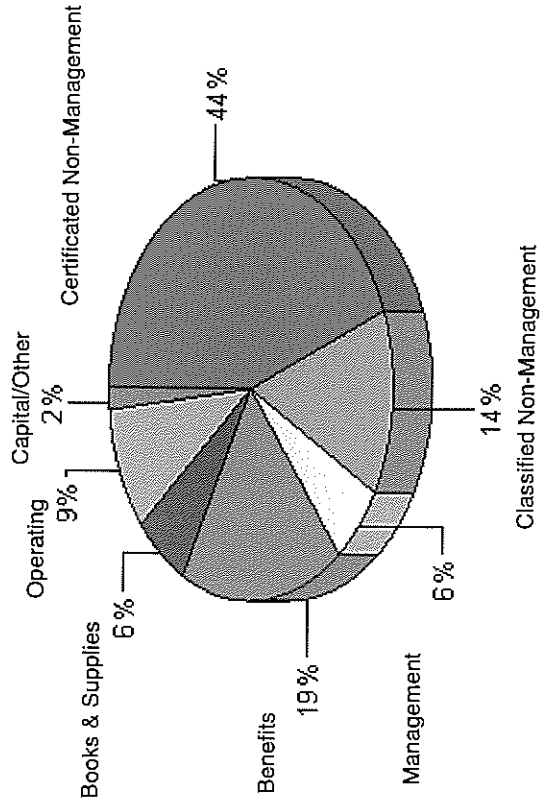

Classified employees include all of the support personnel in the District, including secretaries, accountants, bus drivers, mechanics, painters, and custodial personnel.

The health and welfare benefits of the District represent an additional 15% of payroll for expenses in areas such as medical, dental and life insurance plans, and retirement expenses.

General Fund Expenditures (In Millions)

Certificated Non-Management Salaries	\$107.9
Classified Non-Management Salaries	34.7
Management and Supervisor Salaries	14.8
Employee Benefits	45.7
Books and Supplies	15.3
Operating	23.0
Capital/Other	4.1
Total Expenditures	245.5
Ending Balance	14.9
Total General Fund	\$260.4

Reflects information as of June 2007

General Fund Revenues and Expenses, 1998-99 to 2007-08

Revenues and Expenses, 1998-99 to 2007-08

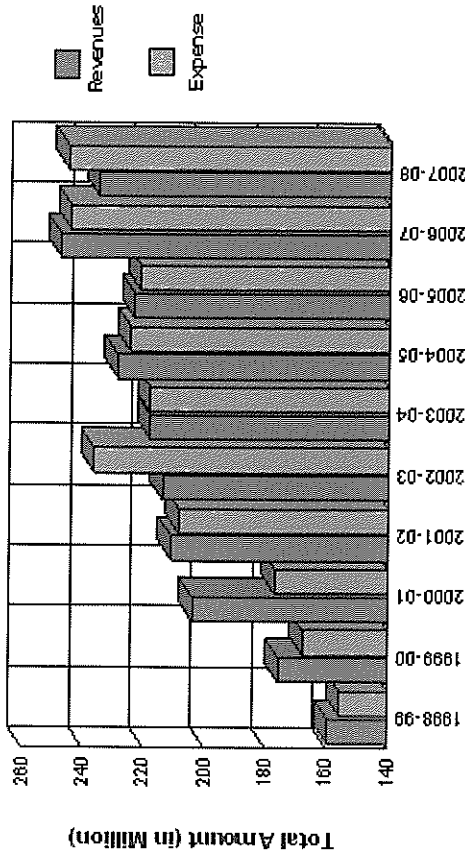

Revenues and Expenses per ADA, 2003-04 to 2007-08

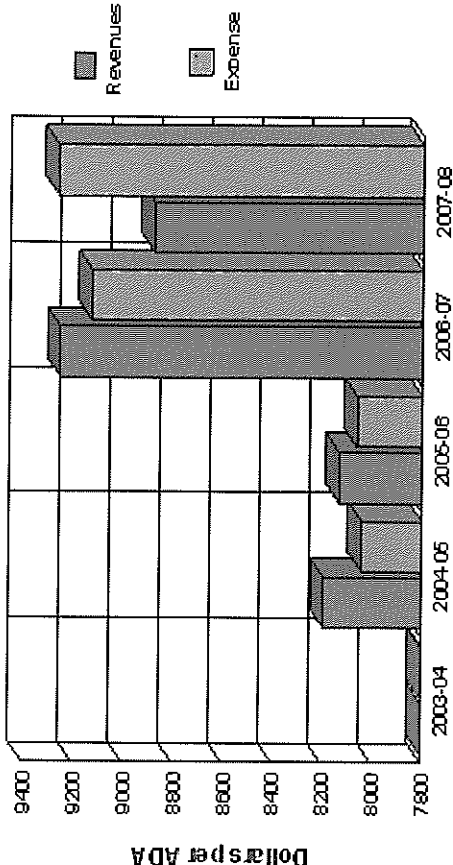

The Education Budget of 2007-08 is Modest in New Growth

California public education has been on a rollercoaster funding cycle for almost all of the last 15 years. In the early 1990s, California's recession led to almost no increase in per-ADA funding for four years. In the mid-'90s, a major increase in state revenues led to an unprecedented new program to reduce class size in grades K-3. In 2000-01, the State Budget provided per-ADA increases close to 11%, but then, for the next three years, education funding rollbacks were again common. The volatility of funding has plagued school district planning for almost a generation.

In 2006-07, California rebounded from the slowing economy and the State Budget provided major new revenues with numerous program improvements. In 2007-08, however, the Governor's initial proposals are more modest. The projected budget includes a 4.53% cost of living increase for schools and little else in the way of increased funding. Approximately 90% of the district's revenue is determined by the State of California and, in turn, state revenues are determined by the growth in the economy. The swing to more modest education growth in 2007-08 is in large part driven by difficulties in balancing a state budget when they face their own budget deficit.

One of the major difficulties facing the budget development process is the huge swing in state funding from one year to the next. Education agencies are not able to project subsequent year revenues and thus it is difficult to plan on a long term basis. Each budget must be managed as almost a single year document with considerable restraint in adopting programs or program increases that are on going.

The graphic display of district revenue and expense shows how the district's revenues have varied widely between fiscal years as the state has gone through its own economic roller-coaster.

Restricted and Unrestricted District Revenues and Expenses, 2007-08

Unrestricted and Restricted Revenues, 2007-08

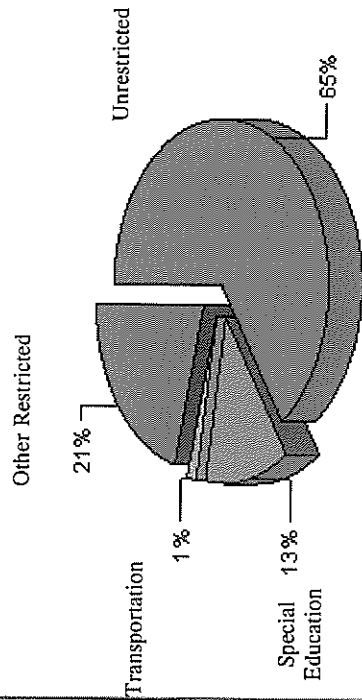

65% of the District's income can be expended as determined by the local agency

A significant portion of California school district income is restricted income and, as such, can only be expended for selected purposes as determined by the granting agency--usually higher levels of government. The balance of the District income is called unrestricted since it can be expended as determined by the local agency for general educational priorities. On average, in 2007-08, California school districts will receive about two-thirds of their income as unrestricted.

The biggest restricted programs in California are Special Education, K-3 Class Size Reduction, and Home-to-School Transportation. Local agencies are obligated, for each of these programs, to expend the income for selected program purposes and in some cases for very micro-managed expenditures as determined by California or federal law.

Unrestricted and Restricted Expenses, 2007-08



For Special Education, ORANGE UNIFIED SCHOOL DISTRICT expends \$38,664,344 to meet program obligations and state and federal law. State and federal Special Education income is significantly less than the obligations of the program. Therefore, the District must use unrestricted or general-purpose income to address the full obligations of Special Education. The difference between the restricted income and the expenditures in Special Education is described as "encroachment," indicating that the expenditures "encroach" on general purpose revenues.

Home-to-School Transportation is another encroaching program on the District's general purpose revenues in the amount of \$3,793,515, or about 53.36% of the entire District transportation expense.

Reflects information as of June 2007

District Reserves and Net Ending Balances, 1998-99 to 2007-08

District Reserves and Net Ending Balance

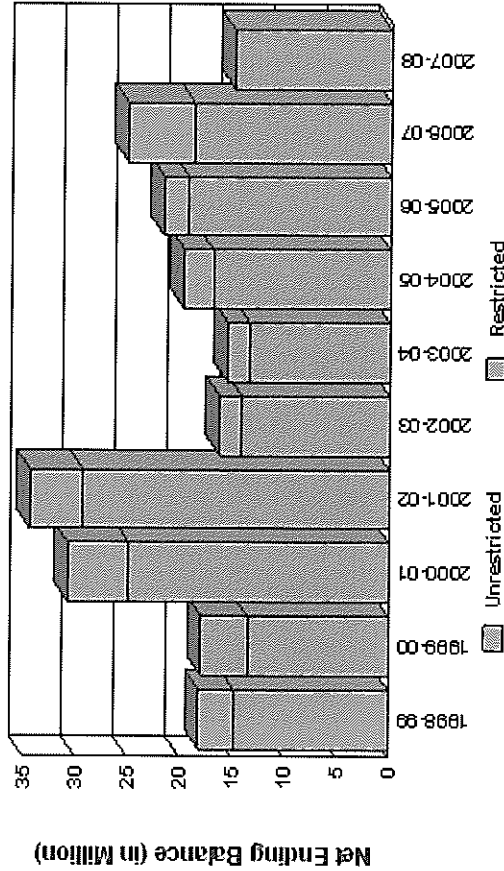

A school district's Net Ending Balance is a district's reserve account to fund unforeseen events or pay for multi-year needs

Revenues that have not been expended during a budget year are carried over into the subsequent year and identified as the District's "Net Ending Balance." In most cases, this is the only reserve account that a school district has for general operational purposes. The Net Ending Balance of one year becomes the Net Beginning Balance of the subsequent year.

Included within the projected Net Ending Balance is a "Reserve for Economic Uncertainties," which is a minimum balance that the state of California requires to be retained to cover unforeseen shortfalls in revenues or higher-than-expected expenditures. The state's minimum "Reserve for Economic Uncertainties" for ORANGE UNIFIED SCHOOL DISTRICT is 3% of the total General Fund expenditures. Many districts have reserves that are higher than the minimum state requirement, due to the significant fluctuations in public education revenues and/or due to local circumstances and risk factors.

Also included in the Net Ending Balance are restricted carryover balances that originated from sources that can only be used for selected purposes. These revenues can only be expended for the purposes determined by the grantor, and the balances in these accounts carry the same restrictions as the originating income. Thus, a Net Ending Balance is composed of two types of accounts--those that are "restricted" that can be used for selected purposes only and those that are "unrestricted" that can be expended by decisions of the local agency.

Net Ending Balance Components (In Thousand)

	2005-06	2006-07 (est)	2007-08 (proj)
Revolving Cash	\$125	\$125	\$125
Stores	141	138	140
Prepaid Expense	0	0	0
Restricted Program Balances	4,683	7,645	456
Reserve for Economic Uncertainties	6,643	7,334	7,365
Reserves Restricted by the Governing Board	0	0	0
Unallocated Balance	10,115	9,890	6,847

Lottery Income and its History

The California State Lottery is projected to yield \$3,126,764, or approximately 1%, of the District's income in 2007-08. While the income is welcome, it will yield only a small portion of the total income needed to support the District's educational program. The income in the budget year, as an example, would be sufficient to buy three textbooks per student, to buy four computers per classroom, or pay for the energy costs for one year.

Lottery income is not a stable source of income for the district, but instead has ranged from a low of \$77 per ADA in 1991-92 to a high of \$176 per ADA in 1988-89. Since the income is not consistent, the expenditures have also varied widely.

Since 1997-98, school districts have been required to use 50% of the growth in Lottery allocations for the purchase of instructional materials. In 2007-08, it is projected that California school districts will receive \$118 per ADA in unrestricted funds and \$19 per ADA restricted for the instructional materials purchase.

The District is proud of its management of the Lottery expenditures for student needs and enhancements.

Lottery income is important, but it is only 1% of the District's total income

Lottery Income History

1988-89 to 2007-08

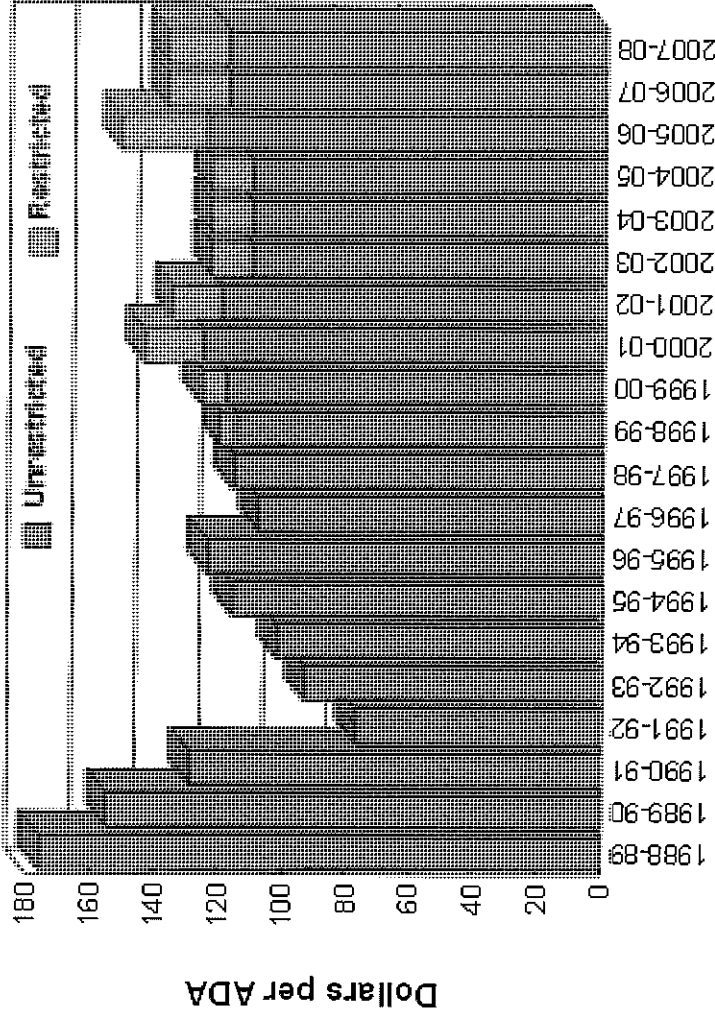

Current and budgeted years are estimated and projected

II

Criteria and Assumptions

BUDGETARY BUILDING BLOCKS

BUDGET CRITERIA

The Board of Education has the final responsibility for the budget. The Board's primary budget development tasks include establishing budget criteria and assumptions, directing, reviewing, and approving the budget.

The criteria for the 2007-08 budget are as follows:

1. The beginning fund balance is inclusive of carryover funds for categorical programs and/or school site program allocations.
2. The beginning fund balance includes statutory reserves for revolving cash (\$125,000), stores inventory (\$140,000), and designated for economic uncertainties (\$7,364,963) that are not available for appropriation.
3. Amounts reserved for economic uncertainties from all legally available sources will be a minimum of three percent of the total General Fund expenditures plus inter-fund transfers out, and in accordance with Educational Code Section 42130 and the provisions of AB 1200.
4. Average daily attendance (ADA) for purposes of the revenue limit calculation will be based upon historical and projected ADA for the ten school months ending on or before April 15. Revenue from revenue limit sources will be based on the most current factors contained in the Governor's proposals for the 2007-08 State Budget and as provided by the California Department of Education, the County Assessor's Office, and Orange County Department of Education.

5. State revenues for lottery funds will be based upon the most current projections provided by School Services of California and the Orange County Department of Education.
6. Federal and State categorical revenues will be based upon the most current projections provided by the grantor agencies, the California Department of Education, and the Orange County Department of Education.
7. Amounts appropriated for salaries and benefits for classroom teachers and aides will be contained within the appropriate General Fund budget categories in an amount not less than 55 percent of the District's current expense for education and in compliance with Education Code 41011 and 41372.
8. Salaries, benefits, and related costs will be charged to the appropriate fund and program and budgeted in accordance with the California School Accounting Manual, Collective Bargaining Agreements, Board Policy, and previous Board action.
9. Categorically-funded programs, except Special Education Master Plan, Transportation, and Education Technology will be self-supporting without encroaching on the Unrestricted General Fund revenues. Increased costs including, but not limited to, salaries and benefits will be covered by appropriate categorical revenue sources. Allowable indirect cost rates will be charged to those categorical programs authorized by the Board of Education.
10. Unrestricted General Fund monies contributed to the Special Education Program as local general fund support will be budgeted as legally required.

BUDGETARY BUILDING BLOCKS

11. Categorical Funds will be expended in accordance with applicable Federal and State compliance requirements and those specified by the grantor agencies.
12. The enrollment counts for purposes of school allocation amounts and principal enrollment projections will be based upon prior-year enrollments (updated as of the third attendance month and again as of the "P1" period of attendance).
13. General Fund allocations to schools for instructional support and operational costs (excluding custodial supplies) will be based upon the current allocation formula. Staffing allocations for schools will be at a ratio in accordance with collective bargaining agreements and guidelines determined by the Board of Education. Each site-level administrator will ensure that current-year expenditures do not exceed appropriations unless authorized by the Superintendent and approved by the Board of Education.
14. General Fund expenditures for non-personnel items at the District level will be budgeted as recommended by each division administrator and approved by the Superintendent. Each District-level administrator will ensure that current-year expenditures do not exceed appropriations unless authorized by the Superintendent and approved by the Board of Education.
15. Statutory benefits, for purposes of payroll expense rates, are based upon the most current rates published by the Orange County Department of Education and subject to change during the year.
16. The Nutrition Services Department and the Child Development Program will be self-supporting for all direct costs including, but not limited to, costs for employee salaries and benefits, equipment repair and replacement, and other capital outlay needs.
17. Amounts appropriated for major deferred maintenance, except the General Fund match requirement, will be budgeted and expended in the Deferred Maintenance Fund.
18. Amounts appropriated for capital projects will be budgeted and expended in the Special Reserve Fund, Capital Facilities Fund, County School Facilities Fund, or Deferred Maintenance Fund. These funds will be self-sufficient.
19. The Board of Education will approve all inter-fund transfers.
20. The Board of Education will adopt the 2007-08 budget on or before July 1, 2007, under the July 1 single-adoption process in accordance with the resolution adopted by the Board.
21. District staff will analyze the impact of the State's Final Budget on the District's Adopted Budget. In accordance with Education Code Section 42127(h)(3), the Board of Education will approve, not less than 45 days after the legislation adopts the Final State Budget, any significant changes impacting the General Fund balance. All other changes will be incorporated in the First Interim Budget and approved by the Board of Education on or before December 15 in accordance with Education Code Sections 33127 and 42127.
22. Items 1 through 21 are subject to change by the Board of Education and/or the Superintendent at any time.

BUDGETARY BUILDING BLOCKS

GENERAL FUND ASSUMPTIONS

Enrollment Assumptions

1. The Orange Unified School District's K-12 enrollment (excluding Charter schools) for 2007-08 is projected to decline to 27,497 using a .622% rate of decline.

Beginning Fund Balance Assumption

2. The total beginning General Fund balance is projected to be \$25,131,175. This is based upon the assumption that 2006/07 revenues will be received and all appropriations expended as reflected in the current June 30, 2007, projections. The beginning balance will be adjusted to the actual ending June 30, 2007, fund balance after the 2006/07 ledgers are closed. All adjustments will be submitted to the Board of Education for approval.

Ending Fund Balance Assumptions

3. The 2007/08 ending General Fund balance is projected to be \$14,933,526 reflecting a net change of \$10,197,650.
4. Components of the ending General Fund Balance include legally required reserves of \$140,000 for stores inventory and \$125,000 for revolving cash.
5. In accordance with Education Code Section 42130 and the provisions of AB 1200, components of the ending General Fund balance include reserves for economic uncertainties. In accordance with this objective, reserves for economic

uncertainties are projected to be \$7,364,963 or 3% of the total General Fund expenditures and transfers out.

6. School site/program carryover balances estimated to be \$758,994, are included in the General Fund expenditures. This represents unspent school site/program allocations that are carried forward to the subsequent budget year. The actual amounts remaining for each site are reallocated back to their program budgets by September 15.
7. After excluding all amounts for legally required reserves, economic uncertainties, and other designated amounts, unrestricted General Fund unappropriated amounts are projected to be \$6,847,436. These funds represent surplus amounts that are not specifically designated and that may be appropriated for Board-approved expenditures.

BUDGETARY BUILDING BLOCKS

Revenue Assumptions

8. The total budgeted attendance of 26,645 (not including District charter schools) reflects a net decrease of 140 ADA in general education, special education, and adult education as compared to 2006/07. Average daily attendance is used for purposes of calculating the Revenue Limit Apportionment.

	ADA
OUSD	26,570.87
Non-Public Schools	74.00
County Special Education	29.56
County Community Schools	348.73
Adult Education	6.00
Sub-Total	<u>27,029.16</u>
EI Rancho Charter MS	1,083.42
Santiago Charter MS	1,051.51
Sub Total (Charter Schools Only)	<u>2,134.93</u>
GRAND TOTAL	<u>29,164.09</u>

9. The Governor's May Revise provides sufficient funding to support the Proposition 98 minimum funding level for education. Healthier than expected state general fund revenues in 2006/07 increased the Proposition 98 minimum guarantee by approximately \$476 million in total for 2006/07 and 2007/08. The May Revise now forecasts the 2007/08 Proposition 98 funding at \$57.6 billion which represents an increase of \$2.2 billion or 4% over 2006/07.

The May Revise provides over \$800 million in one-time and on-going augmentations to the Governor's January proposal. However, subsequent to the release of the Governor's May Revise, the Legislative Analyst's review of the Governor's proposal identified an error resulting in the understatement of 2007/08 K-12 expenditures of \$364 million. The error was due to the \$350 million provided in the current year for revenue limit equalization not being carried forward in the budget year. When the 2007/08 cost of living adjustment (COLA) of 4.53% is factored, less the .48% projected decline in enrollment, the error resulted in the understatement of projected expenditures of \$364 million. This shortfall will need to be addressed by the Legislature in finalizing the 2007/08 Budget.

The Governor's May proposal includes funding for an increased COLA of 4.53% which is 0.49% higher than projected in the Governor's January proposal. The COLA will be applied to district and county office revenue limits as well as most state categorical programs. The Governor's Budget also includes funding for statutory enrollment growth. However, due to the continuing decline in student enrollment statewide, there is an actual projected decrease in growth funding of (\$293) million or .48% representing a projected decrease in students of 28,000 statewide. This is an increase from the .39% decrease forecast in the Governor's January proposal indicating the declining enrollment trend statewide continues to accelerate.

10. Federal revenue sources are projected to be \$13,130,286 in 2007/08. The actual amounts of carryover grant balances for all Federal program revenues are reallocated back to their program budgets by September 15.

BUDGETARY BUILDING BLOCKS

11. A. Other State revenue sources are projected to be \$52,249,605. The Special Education Master Plan apportionment includes a funded COLA of 4.53%.
B. All other State programs are budgeted at 2006/07 levels, with 4.53% COLA. State entitlement carryover balances, estimated to be \$6,353,630 are included in the ending General Fund Balance reserves. The actual amount of carryover entitlement balances are reallocated back to their program budgets by September 15. Additionally, prior-year carryover grant amounts are excluded in the 2007/08 budget. Actual carryover balances are added to these programs in September with the unaudited actuals.
C. One-time funds are excluded in projections for 2007/08. New, one-time Block Grant Funds are not anticipated.
12. Based on the recommendations of School Services of California, Inc., Lottery Funds are projected to decrease to \$137/ADA, \$118 Regular, and \$19 Instructional Materials.
13. Other Local Income is projected to be \$8,898,082. Based upon fluctuating, low interest rates, Interest Income is projected to be \$1,870,000.

Expenditure Assumptions

14. Expenditures associated with State and Federal categorical programs are projected not-to-exceed program revenues, except Special Education Master Plan, Transportation Services, and Education Technology. In addition, the Routine Restricted Maintenance Match program requires an

unrestricted General Fund contribution. The total unrestricted General Fund contribution to these four categorical programs is projected to be \$20,451,741 (Special Education \$9,007,427, Transportation \$3,793,515, Education Technology \$285,714, and Routine Restricted Maintenance Match \$7,365,085. State funds for Special Education, Transportation, and Education Technology are inadequate to provide the services necessary to meet the students served. The match for Routine Restricted Maintenance in 2004-05 Education Code Section 17070.75 was amended, which lowered the routine restricted maintenance requirement for school agencies to 2% of the total general fund expenditures including transfers out and other financing uses. This was a one-time flexibility option, only pertaining to 2004-05. For the 2007-08 budget year, the annual routine restricted maintenance requirement is back to 3% of the total general fund budget.

15. Certificated salaries are projected to increase on average of 1.7% for step/column movement, or \$1,722,100.
16. Classified salaries are projected to increase an average of 1.7% or \$807,500 for step movement. Included are full-year salary costs for positions filled at various intervals in 2007/08.
17. Cost-of-living adjustments (COLA) for all salary schedules are projected to be 0%.
18. Health and Welfare benefits for all plans combined are projected to increase by 14%. This increase is not included in the budgeted amount for health and welfare.

BUDGETARY BUILDING BLOCKS

19. Statutory benefits are projected to be as follows:

STRS	8.250%
PERS*	9.306%
OASDI	6.200%
Medicare	1.450%
Unemployment	.050%
Worker's Comp	1.640%
PERS Reduction Transfer	3.714%
PERS EPMC	7.000%
OPEB	1.150%

* The total PERS costs equals 13.02%. The State reduces the Revenue Limit apportionment by the calculated PERS Reduction amount. Therefore, this represents a total cost to the District.

20. Property and liability insurance expenditures are projected to be \$1,000,000, an increase of \$33,672 or 3.4% from 2006/07. Utilities are projected to be \$4,875,900, an increase of \$41,870 from 2006/07.

21. Professional/Consulting Services and Operating Expenditures are projected to be \$10,846,028 .

22. Capital outlay is projected to be \$250,000 .

23. Transfers out are projected to be \$1,215,600. The District's deferred maintenance matching funds are projected to be \$1,215,600. This match requirement is based on one-half of one percent of Statewide average General Fund expenditures. In total, transfers out are projected to be \$1,215,600.

24. School site carryover balances are projected to be \$268,817, representing unspent allocation amounts that are carried forward from the prior year. The actual amount for each school site will be reallocated back to their specific program budget by September 15.

25. Other Outgo is projected to be \$2,790,125 primarily for transfers to the Orange County Department of Education for Special Education excess costs and out-of-home care costs for county educated students. Based on information obtained from the Orange County Department of Education, excess costs are projected to decrease by \$43,000 and out-of-home care costs projected to be \$507,878 in 2007/08. Excess costs are billed one year in arrears.

26. All prior-year, on-time expenditures (and applicable revenues) have been eliminated from the 2007/08 budget. All other expenditures (not identified above) are projected to remain flat, with no inflation increases.

ENROLLMENT

Projecting enrollment is important because the District's enrollment establishes the basis of state revenue, staffing needs, and planning for facilities. Change in enrollment for the past six years is as follows:

2001/02	.2%
2002/03	.5%
2003/04	(.3%)
2004/05	.4%
2005/06	(2.6%)
2006/07	(2.7%)
2007/08 est.	(.6%)

BUDGETARY BUILDING BLOCKS

Enrollment Versus Average Daily Attendance (ADA)

Enrollment represents the number of students actually enrolled in a District school on any given date. For the purposes of predicting and comparing historical enrollment, the measurement date used is the "P2" period of apportionment.

ADA is the measure of attendance activity that represents the actual count of students present. ADA reporting to the State is measured on three dates:

1. December 30 The First Period "P1" Report
2. April 15 The Second Period "P2" Report
3. End of School The Annual ADA Report

The ratio between ADA and enrollment in California Public Schools is approximately 95%. For the past six years the ratio between ADA and enrollment in Orange Unified is as follows:

2001/02	96.0%
2002/03	95.6%
2003/04	96.0%
2004/05	95.7%
2005/06	96.6%
2006/07	96.8 %
2007/08 est.	96.4%

*Three-year attendance rate average is 96.4%

ENROLLMENT MEASUREMENTS AND USES

Enrollment Projections

*Prior year "P2" period of attendance enrollment trends (updated periodically as actual data is obtained) are used for:

- *Multi-Year Financial Forecasts
- Facility Planning--CBEDS
- Initial Staffing Allocations—Spring Registrations

First Period Average Daily Attendance – "P1" (December 30)

- School Improvement Program
- Economic Impact Aid

Second Period Average Daily Attendance – "P2" (April 15)

- Revenue Limit Apportionment
 - Instructional Materials (K-8)
 - Gifted and Talented Education
- Annual Average Daily Attendance (end of school year)**

Lottery Revenues (uses prior year's annual ADA)

STAFFING COMPOSITION

Full-time Equivalents (FTEs)

Staffing units are reflected as full-time equivalents (FTEs). Oftentimes, FTEs are shown as fractions. For example, teacher FTEs are related to teach periods (0.2 FTE = 1 period, 1.0 FTE = 5 periods, etc.). Non-teaching FTEs are related to hours worked (0.375 FTE = 3 hours, 1.0 FTE = 8 hours, etc.).

BUDGETARY BUILDING BLOCKS

School Staffing – Certificated Personnel

The District's staffing for teachers is computed in terms of student enrollment with student/teacher ratios of 19:1 for grades 1-2, 30:1 for grades K and 3-6, 32:1 for grades 7-12, and 20:1 for 9th grade English and math.

School Staffing – Classified Personnel

The District's clerical staffing for classified personnel assigned to school sites is computed in terms of the instructional levels (elementary, intermediate, and high school) associated to the school site.

Elementary Schools:

- Regular enrollment x 1.75 minutes plus Special Education enrollment x 2.0 minutes
- Divide the sum by 60 minutes and round to the nearest half hour
- Minimum staffing is 1½ hours (8 hours at Silverado Elementary)
- LMA is included in formula
- Health formula is .00282 x enrollment

Intermediate Schools:

- Regular enrollment x 2.825 minutes plus Special Education enrollment x 3.25 minutes
- Divide the sum by 60 minutes and round to the nearest half hour
- Minimum staffing is 3½
- Health Clerk of 6.5 hours is not included in formula; Secondary LMA is included.

High Schools:

- Same as intermediate schools, except that minimum staffing is 80 hours

To determine custodial staffing, the District uses staffing formulas that are based on projected enrollments by school site, school building square footage, number of teachers assigned to a site, and number of rooms.

Special Project Personnel

Certificated and classified personnel are allocated to special projects on the basis of Federal and State categorical program plans. Personnel assigned to a categorical program are funded by program and not the District's unrestricted General Fund.

Substitutes

Substitutes serving in District-funded programs are usually utilized for one of three reasons: (1) illness or leave of absence provisions, (2) in-services, or (3) short-term resource. Each of these categories is centrally budgeted based on the prior-year expense and current-year needs defined by each program manager. For categorical programs, all substitute expenses are charged to the applicable program.

Non-School Site Staffing

Non-school site staffing (i.e. central office support services, management personnel, etc.) is based on available unrestricted General Fund resources with attention given to District priorities.

BUDGETARY BUILDING BLOCKS

SCHOOL RESOURCE ALLOCATIONS

Allocation of schools' resources are on a per-pupil basis, using prior-year enrollment updated after the end of the first attendance month and again at "P1" attendance reporting period enrollment.

School resources are expected to provide funding for the following operational needs:

	<u>K-6</u>	<u>7-8</u>	<u>9-12</u>
Other books	X	X	X
Instructional materials & supplies	X	X	X
Office supplies	X	X	X
Postage/printing	X	X	X
Library supplies	X	X	X
Conference, travel, and consultants *	X	X	X
Instructional media material/supplies	X	X	X
New equipment	X	X	X
Equipment replacement	X	X	X
Equipment repair	X	X	X

* *Not funded by categorical programs*

The 2007/08 school resources are:

K-6	7-8	9-12
37.50	50.25	58.75

NOTE: School site carryover balances are estimated to be \$268,817 from prior-year unused school resources and are not included in the 2007/08 budget. The actual carryover amounts are reallocated back to each school site's program budget by September 15.

III
General Fund

ANNUAL BUDGET REPORT:
July 1, 2007 Single Budget Adoption

This budget was developed using the state-adopted Criteria and Standards. It was filed and adopted subsequent to a public hearing by the governing board of the school district.
(Pursuant to Education Code sections 33129 and 42127)

Budget available for inspection at:

Public Hearing:

Place: 1401 N. Handy, OUSD Business Services
Date: June 18, 2007

Place: 1401 N. Handy, OUSD Board Room
Date: June 21, 2007
Time: 07:30 PM

Adoption Date: June 21, 2007

Signed: _____
Clerk/Secretary of the Governing Board
(Original signature required)

Contact person for additional information on the budget reports:

Name: Barbara Stephens

Telephone: (714) 628-4044

Title: Director - Fiscal Assistance

E-mail: _____

Criteria and Standards Review Summary

The following summary is automatically completed based on data provided in the Criteria and Standards Review (Form 01CS). Criteria and standards that are "Not Met," and supplemental information and additional fiscal indicators that are "Yes," may indicate areas of potential concern for fiscal solvency purposes and should be carefully reviewed.

CRITERIA AND STANDARDS			Met	Not Met
1	Average Daily Attendance	Budgeted (funded) ADA has not been overestimated by more than the standard for the prior year, or two or more of the previous three years.	X	
2	Enrollment	Enrollment has not been overestimated by more than the standard for the prior year, or two or more of the previous three years.	X	
3	ADA to Enrollment Ratio	Projected second period (P-2) ADA to enrollment ratio is consistent with historical ratios for the budget and two subsequent years.		X
4	Revenue Limit	Projected change in revenue limit is within the standard for the budget and two subsequent years.	X	

CRITERIA AND STANDARDS (continued)			Met	Not Met
5	Salaries and Benefits	Projected ratios of salaries and benefits to total expenditures are consistent with historical ratios for the budget and two subsequent years.		X
6	Other Revenues and Expenditures	Projected other operating revenues and expenditures (e.g., federal revenue, other state revenue, books and supplies) are consistent with historical amounts for the budget and two subsequent years.		X
7a	Deferred Maintenance	If applicable, required deferred maintenance facilities funding is included in the budget.	X	
7b	Ongoing and Major Maintenance Account	If applicable, required contribution to the ongoing and major maintenance account (i.e., restricted maintenance account) is included in the budget.	X	
8	Deficit Spending	Deficit spending, if any, has not exceeded the standard for two or more of the last three years.	X	
9	Fund Balance	Unrestricted general fund beginning balance has not been overestimated by more than the standard for two or more of the last three years.	X	
10	Reserves	Projected reserves (e.g., designated for economic uncertainties, unappropriated amounts) meet minimum requirements for the budget and two subsequent years.	X	

SUPPLEMENTAL INFORMATION			No	Yes
S1	Contingent Liabilities	Are there known or contingent liabilities (e.g., financial or program audits, litigation, state compliance reviews) that may impact the budget?	X	
S2	Using One-time Revenues to Fund Ongoing Expenditures	Are there ongoing general fund expenditures in excess of one percent of the total general fund expenditures that are funded with one-time resources?	X	
S3	Using Ongoing Revenues to Fund One-time Expenditures	Are there large non-recurring general fund expenditures that are funded with ongoing general fund revenues?	X	
S4	Contingent Revenues	Are any projected revenues for the budget or two subsequent years contingent on reauthorization by the local government, special legislation, or other definitive act (e.g., parcel tax, forest reserves)?	X	
S5	Contributions	Have contributions from unrestricted to restricted programs, or transfers to or from the general fund to cover operating deficits, changed by more than ten percent for the budget or two subsequent years?		X
S6	Long-term Commitments	Does the district have long-term (multiyear) commitments or debt agreements?		X
		• If yes, is the change in long-term commitments and debt agreements greater than the change in revenues for the budget or two subsequent years?		X

SUPPLEMENTAL INFORMATION (continued)			No	Yes
S7a	Postemployment Benefits Other than Pensions	Does the district provide postemployment benefits other than pensions (OPEB)?		X
		• If yes, are they lifetime benefits?		X
		• If yes, do benefits continue beyond age 65?		X
		• If yes, are benefits funded by pay-as-you-go?		X
S7b	Other Self-insured Benefits	Does the district provide other self-insured benefits (e.g., workers' compensation)?		X
		• If yes, are benefits funded by pay-as-you-go?	X	
S8	Status of Labor Agreements	Are salary and benefit negotiations still open for:		
		• Certificated? (Section S8A, Line1)		X
		• Classified? (Section S8B, Line 1)		X
		• Management/supervisor/confidential? (Section S8C, Line1)		X

ADDITIONAL FISCAL INDICATORS			No	Yes
A1	Negative Cash Flow	Do cash flow projections show that the district will end the budget year with a negative cash balance in the general fund?	X	
A2	Independent Position Control	Is personnel position control independent from the payroll system?		X
A3	Declining Enrollment	Is enrollment decreasing in both the prior year and budget year?		X
A4	New Charter Schools Impacting District Enrollment	Are any new charter schools operating in district boundaries that are impacting the district's enrollment, either in the prior year or budget year?	X	
A5	Salary Increases Exceed COLA	Has the district entered into a bargaining agreement where any of the budget or subsequent years of the agreement would result in salary increases that are expected to exceed the projected state cost-of-living adjustment?	X	
A6	Uncapped Health Benefits	Does the district provide uncapped health benefits for current or retired employees?	X	
A7	Independent Financial System	Is the district's financial system independent from the county office system?		X
A8	Fiscal Distress Reports	Does the district have any reports that indicate fiscal distress? If yes, provide copies to the COE, pursuant to EC 42127.6(a).	X	
A9	Change of CBO or Superintendent	Have there been personnel changes in the superintendent or chief business official (CBO) positions within the last 12 months?	X	

ANNUAL CERTIFICATION REGARDING SELF-INSURED WORKERS' COMPENSATION CLAIMS

Pursuant to E.C. Section 42141, if a school district, either individually or as a member of a joint powers agency, is self-insured for workers' compensation claims, the superintendent of the school district annually shall provide information to the governing board of the school district regarding the estimated accrued but unfunded cost of those claims. The governing board annually shall certify to the county superintendent of schools the amount of money, if any, that it has decided to reserve in its budget for the cost of those claims.

To the County Superintendent of Schools:

() Our district is self-insured for workers' compensation claims as defined in Education Code Section 42141(a):

Total liabilities actuarially determined:	\$ 4,489,000.00
Less: Amount of total liabilities reserved in budget:	\$ 4,489,000.00
Estimated accrued but unfunded liabilities:	\$ 0.00

() This school district is self-insured for workers' compensation claims through a JPA, and offers the following information:

() This school district is not self-insured for workers' compensation claims.

Signed _____
Clerk/Secretary of the Governing Board
(Original signature required)

Date of Meeting: Jun 21, 2007

For additional information on this certification, please contact:

Name: Barbara Lichten

Title: Director - Risk Management

Telephone: (714) 628-4190

E-mail: _____

Description	2006-07 Estimated Actuals			2007-08 Budget		
	P-2 ADA	Annual ADA	Revenue Limit ADA	Estimated P-2 ADA	Estimated Annual ADA	Estimated Revenue Limit ADA
ELEMENTARY						
General Education			16,994.56	16,578.68	16,578.68	16,725.94
a. Kindergarten	1,894.49	1,894.49				
b. Grades One through Three	6,183.96	6,183.96				
c. Grades Four through Six	6,490.51	6,490.51				
d. Grades Seven and Eight	2,405.23	2,405.23				
e. Opportunity Schools and Full-day Opportunity Classes						
f. Home and Hospital	20.37	20.37				
g. Community Day School						
2 Special Education						
a. Special Day Class	526.32	526.32	526.32	515.49	515.49	515.49
b. Nonpublic, Nonsectarian Schools (E.C. 56366[a][7])	23.97	23.97	23.97	23.97	23.97	23.97
c. Nonpublic, Nonsectarian Schools - Licensed Children's Institution	14.76	14.76	14.76	14.76	14.76	14.76
3. TOTAL, ELEMENTARY	17,559.61	17,559.61	17,559.61	17,132.90	17,132.90	17,280.16
HIGH SCHOOL						
4. General Education			8,811.07	8,944.02	8,944.02	8,944.02
a. Grades Nine through Twelve	8,499.01	8,499.01				
b. Continuation Education	272.51	272.51				
c. Opportunity Schools and Full-day Opportunity Classes						
d. Home and Hospital	39.55	39.55				
e. Community Day School						
Special Education						
a. Special Day Class	379.16	379.16	379.16	385.42	385.42	385.42
b. Nonpublic, Nonsectarian Schools (E.C. 56366[a][7])	23.46	25.89	25.89	25.89	25.89	25.89
c. Nonpublic, Nonsectarian Schools - Licensed Children's Institution	9.38	9.38	9.38	9.38	9.38	9.38
TOTAL, HIGH SCHOOL	9,223.07	9,225.50	9,225.50	9,364.71	9,364.71	9,364.71
COUNTY SUPPLEMENT						
County Community Schools (E.C.1982[a])						
a. Elementary	136.84	136.84	136.84	136.84	136.84	136.84
b. High School	211.89	211.89	211.89	211.89	211.89	211.89
Special Education						
a. Special Day Class - Elementary	8.46	8.46	8.46	8.46	8.46	8.46
b. Special Day Class - High School	21.10	21.10	21.10	21.10	21.10	21.10
c. Nonpublic, Nonsectarian Schools - Elementary						
d. Nonpublic, Nonsectarian Schools - High School						
e. Nonpublic, Nonsectarian Schools - Licensed Children's Institution - Elementary						
f. Nonpublic, Nonsectarian Schools - Licensed Children's Institution - High School						
TOTAL, ADA REPORTED BY COUNTY OFFICES	378.29	378.29	378.29	378.29	378.29	378.29
TOTAL, K-12 ADA (sum lines 3, 6, and 9)	27,160.97	27,163.40	27,163.40	26,875.90	26,875.90	27,023.16
ADA for Necessary Small Schools also included in lines 3 and 6.						
REGIONAL OCCUPATIONAL CENTERS & PROGRAMS						

Description	2006-07 Estimated Actuals			2007-08 Budget		
	P-2 ADA	Annual ADA	Revenue Limit ADA	Estimated P-2 ADA	Estimated Annual ADA	Estimated Revenue Limit ADA
CLASSES FOR ADULTS						
13. Concurrently Enrolled Secondary Students						
14. Adults Enrolled, State Apportioned	5.59	5.59	5.59	6.00	6.00	6.00
15. Students 21 Years or Older and Students 19 or Older Not Continuously Enrolled Since Their 18th Birthday, Participating in Full-Time Independent Study						
16. TOTAL, CLASSES FOR ADULTS (sum lines 13 through 15)	5.59	5.59	5.59	6.00	6.00	6.00
17. Adults in Correctional Facilities						
18. TOTAL, ADA (sum lines 10, 12, 16, and 17)	27,166.56	27,168.99	27,168.99	26,881.90	26,881.90	27,029.16
SUPPLEMENTAL INSTRUCTIONAL HOURS						
19. ELEMENTARY	175,023.00	181,409.00	181,409.00	181,409.00	181,409.00	181,409.00
20. HIGH SCHOOL	281,214.00	300,440.00	300,440.00	320,440.00	320,440.00	320,440.00
21. TOTAL, SUPPLEMENTAL INSTRUCTIONAL HOURS (sum lines 19 and 20)	456,237.00	481,849.00	481,849.00	501,849.00	501,849.00	501,849.00
COMMUNITY DAY SCHOOLS - Additional Funds						
22. ELEMENTARY						
a. ADA for 5th & 6th Hours						
b. Pupil Hours for 7th & 8th Hours						
23. HIGH SCHOOL						
a. ADA for 5th & 6th Hours						
b. Pupil Hours for 7th & 8th Hours						
CHARTER SCHOOLS						
24. Charter ADA Funded Through the Block Grant						
a. Charters Sponsored by Unified Districts - Resident (E.C. 47660)	2,109.77	2,109.77	2,109.77	2,109.77	2,109.77	2,109.77
b. All Other Block Grant Funded Charters	25.16	25.16	25.16	25.16	25.16	25.16
25. Charter ADA Funded Through the Revenue Limit						
26. TOTAL, CHARTER SCHOOLS ADA (sum lines 24a, 24b and 25)	2,134.93	2,134.93	2,134.93	2,134.93	2,134.93	2,134.93
27. SUPPLEMENTAL INSTRUCTIONAL HOURS	39,336.00	49,649.00	49,649.00	49,649.00	49,649.00	49,649.00

July 1 Budget (Single Adoption)
 General Fund
 Revenue Limit Summary

Orange Unified
 Orange County

30 66621 0000000
 Form RL

Description	Principal Appt. Software Data ID	2006-07 Estimated Actuals	2007-08 Budget
BASE REVENUE LIMIT PER ADA			
1. Base Revenue Limit per ADA (prior year)	0025	5,151.46	5,534.43
2. Inflation Increase	0041	308.00	252.00
3. All Other Adjustments	0042, 0525	74.97	
4. TOTAL, BASE REVENUE LIMIT PER ADA (Sum Lines 1 through 3)	0024	5,534.43	5,786.43
REVENUE LIMIT SUBJECT TO DEFICIT			
5. Total Base Revenue Limit			
a. Base Revenue Limit per ADA (from Line 4)	0024	5,534.43	5,786.43
b. Revenue Limit ADA	0033	27,163.40	27,023.16
c. Total Base Revenue Limit (Lines 5a times 5b)	0269	150,333,935.86	156,367,623.72
6. Allowance for Necessary Small School	0489		
7. Gain or Loss from Interdistrict Attendance Agreements	0272		
8. Meals for Needy Pupils	0090		
9. Special Revenue Limit Adjustments	0274		
10. One-time Equalization Adjustments	0275		
11. Miscellaneous Revenue Limit Adjustments	0276		
12. Less: All Charter District Revenue Limit Adjustment	0217		
13. Beginning Teacher Salary Incentive Funding	0138	504,244.00	516,896.00
14. Less: Class Size Penalties Adjustment	0173		
15. REVENUE LIMIT SUBJECT TO DEFICIT (Sum Lines 5c through 11, plus Line 13, minus Lines 12 and 14)	0082	150,838,179.86	156,884,519.72
DEFICIT CALCULATION			
16. Deficit Factor (E.C. Section 42238.146(b))	0281	1.00000	1.00000
17. TOTAL DEFICITED REVENUE LIMIT (Line 15 times Line 16)	0284	150,838,179.86	156,884,519.72
OTHER REVENUE LIMIT ITEMS			
18. Unemployment Insurance Revenue	0060	29,277.00	32,836.00
19. Less: Longer Day/Year Penalty	0287		
20. Less: Excess ROC/P Reserves Adjustment	0288		
21. Less: PERS Reduction	0195	1,028,865.00	1,060,910.00
22. PERS Safety Adjustment	0205		
23. TOTAL, OTHER REVENUE LIMIT ITEMS (Sum Lines 18 and 22, minus Lines 19 through 21)	---	(999,588.00)	(1,028,074.00)
24. TOTAL REVENUE LIMIT (Sum Lines 17 and 23)	0088	149,838,591.86	155,856,445.72

Description	Principal Appt. Software Data ID	2006-07 Estimated Actuals	2007-08 Budget
REVENUE LIMIT PORTION OF LOCAL SOURCES			
25. Property Taxes	0117	112,246,553.00	116,175,182.00
26. Miscellaneous Funds	0078		
27. Community Redevelopment Funds	0079	4,137.00	4,137.00
28. Less: Charter Schools In-lieu Taxes	0124	8,179,258.00	8,549,434.00
29. TOTAL, REVENUE LIMIT - LOCAL SOURCES (Sum Lines 25 through 27, minus Line 28)	0126	104,071,432.00	107,629,885.00
30. Charter School General Purpose Block Grant Offset (Unified Districts Only)	0293		
31. STATE AID PORTION OF REVENUE LIMIT (Sum Line 24, minus Lines 29 and 30. If negative, then zero)	0111	45,767,159.86	48,226,560.72
OTHER ITEMS			
32. Less: County Office Funds Transfer	0458	2,086,315.00	2,181,313.00
33. Core Academic Program	9001	583,583.00	
34. California High School Exit Exam	9002	1,083,646.00	
35. Pupil Promotion and Retention and Low STAR Score Programs	9003	158,995.00	
36. Apprenticeship Funding	9006		
37. Community Day School Additional Funding	9007		
38. Basic Aid "Choice"/Court Ordered Voluntary Pupil Transfer	0266		
39. Basic Aid Supplement Charter School Adjustment	0493		
40. All Other Adjustments	---		
41. TOTAL, OTHER ITEMS (Sum Lines 33 through 40, minus Line 32)	---	(260,091.00)	(2,181,313.00)
42. TOTAL, STATE AID PORTION OF REVENUE LIMIT (Sum Lines 31 and 41) (This amount should agree with Object 8011)	---	45,507,068.86	46,045,247.72
43. Less: Revenue Limit State Apportionment Receipts	---		
44. NET ACCRUAL TO STATE AID - REVENUE LIMIT (Line 42 minus Line 43)	---	45,507,068.86	

OTHER NON REVENUE LIMIT ITEMS (Should be recorded in Object 8311 beginning in 2007-08)			
45. Core Academic Program	9001		601,496.00
46. California High School Exit Exam	9002		1,174,461.00
47. Pupil Promotion and Retention and Low STAR Score Programs	9003		203,895.00
48. Apprenticeship Funding	9006		
49. Community Day School Additional Funding	9007		

July 1 Budget (Single Adoption)
2006-07 Estimated Actuals
LOTTERY REPORT
Revenues, Expenditures and
Ending Balances - All Funds

Description	Object Codes	State Lottery (Unrestricted) (Resource 1100)	Transferred to Other Resources for Expenditure	Lottery Instructional Materials (Resource 6300)*	Totals
REVENUES					
1. Beginning Balance	9791-9795	0.00		0.00	0.00
2. State Lottery Revenue	8560	3,501,650.00		563,825.00	4,065,475.00
3. Other Local Revenue	8600-8799	0.00		0.00	0.00
4. Transfers from Funds of Lapsed/Reorganized Districts	8965	0.00		0.00	0.00
5. Contributions from Unrestricted Resources (Total must be zero)	8980	0.00			0.00
6. Total Available (Sum Lines A1 through A5)		3,501,650.00	0.00	563,825.00	4,065,475.00
EXPENDITURES					
1. Certificated Salaries	1000-1999	2,288,056.00			2,288,056.00
2. Classified Salaries	2000-2999	425,271.00			425,271.00
3. Employee Benefits	3000-3999	380,932.00			380,932.00
4. Books and Supplies	4000-4999	8,966.00		563,825.00	572,791.00
5. a. Services and Other Operating Expenditures (Resource 1100)	5000-5999	371,255.00			371,255.00
b. Services and Other Operating Expenditures (Resource 6300)	5000-5999, except 5710, 5800				
c. Duplicating Costs for Instructional Materials (Resource 6300)	5710, 5800				
6. Capital Outlay	6000-6999	16,989.00			16,989.00
7. Tuition	7100-7199	0.00			0.00
8. Other Transfers Out	7200-7299	0.00			0.00
9. Direct Support Costs	7300-7399				
10. Debt Service	7400-7499	10,181.00			10,181.00
11. Other Uses	7630-7699	0.00			0.00
12. Total Expenditures (Sum Lines B1 through B11)		3,501,650.00	0.00	563,825.00	4,065,475.00
ENDING BALANCE (Must equal Line A6 minus Line B12)	979Z	0.00	0.00	0.00	0.00

Data from this report will be used to prepare a report to the Legislature as required by Control Section 24.60 of the Budget Act

Pursuant to Government Code Section 8880.4(a)(2) and the definition in Education Code Section 60010(h), Resource 6300 funds are to be used for the purchase of instructional materials only. Any amounts in the shaded cells of this column should be reviewed for appropriateness.

Description	2006-07 Actual	2007-08 Budget	% Diff.
SELPA Name: Orange Unified (BM)			
Date allocation plan approved by SELPA governance:	Jun-21, 2007		
I. TOTAL SELPA REVENUES			
A. Base Plus Taxes, IDEA, and Excess ERAF			
1. Base Apportionment	12,529,148.03	13,289,522.81	6.07%
2. Local Special Education Property Taxes			0.00%
3. Federal IDEA, Part B, Local Assistance Grants	4,978,314.00	4,978,314.00	0.00%
4. Applicable Excess ERAF			0.00%
5. Total Base Apportionment, Taxes, IDEA, and Excess ERAF	17,507,462.03	18,267,836.81	4.34%
B. COLA Apportionment	789,786.07	638,777.77	-19.12%
C. Growth Apportionment or Declining ADA Adjustment	(281,080.92)	(365,755.91)	30.12%
D. Special Disabilities Adjustment Apportionment	1,307,212.66	1,283,010.22	-1.85%
E. Subtotal (Sum of lines A.5, B, C, and D)	19,323,379.84	19,823,868.89	2.59%
F. Program Specialist/Regionalized Services Apportionment	418,635.39	433,249.31	3.49%
G. Low Incidence Materials and Equipment Apportionment	38,796.78	38,796.78	0.00%
H. Out of Home Care Apportionment	2,236,156.00	2,320,871.00	3.79%
I. NPS Extraordinary Cost Pool Apportionment			0.00%
J. Adjustment for NSS with Declining Enrollment			0.00%
K. Grand Total Apportionment, Taxes, IDEA, and Excess ERAF (Sum of lines E through J)	22,016,968.01	22,616,785.98	2.72%
L. Mental Health Apportionment	150,384.21	149,461.86	-0.61%
M. State Mandate Settlement (SB 982/CH 203, Statutes of 2001)	131,835.00	131,835.00	0.00%
N. Federal IDEA Local Assistance Grants - Preschool	244,595.00	241,277.00	-1.36%
O. Federal IDEA - Section 619 Preschool	145,667.00	141,566.00	-2.82%
P. Other Federal Discretionary Grants	417,655.00	405,712.00	-2.86%
Q. Other Adjustments	296,207.06		-100.00%
R. Total SELPA Revenues (Sum lines K through Q)	23,403,311.28	23,686,637.84	1.21%
II. ALLOCATION TO SELPA MEMBERS			
Orange Unified (BM00)	23,403,311.28	23,686,637.84	1.21%
Total Allocations (Sum all lines in Section II) (Amount must equal Line I.R)	23,403,311.28	23,686,637.84	1.21%
Preparer Name: <u>Barbara Stephens</u>			
Title: <u>Director - Fiscal Assistance</u>			
Phone: <u>(714) 628-4044</u>			

Current Expense Formula/Minimum Classroom Compensation

PART I - CURRENT EXPENSE FORMULA	Total Expense for Year (1)	EDP No.	Reductions (See Note 1) (2)	EDP No.	Current Expense of Education (Col 1 - Col 2) (3)	EDP No.	Reductions (Extracted) (See Note 2) (4a)	Reductions (Overrides*) (See Note 2) (4b)	EDP No.	Current Expense-Part II (Col 3 - Col 4) (5)	EDP No.
100 - Certificated Salaries	115,792,183.00	301	1,612,206.00	303	114,179,977.00	305	3,015,265.00		307	111,164,712.00	309
2000 - Classified Salaries	36,562,605.00	311	581,533.00	313	35,981,072.00	315	4,995,802.00		317	30,985,270.00	319
300 - Employee Benefits (Excluding 3800)	45,687,151.00	321	6,703,071.00	323	38,984,080.00	325	2,305,199.00		327	36,678,881.00	329
4000 - Books, Supplies Fringe Replace. (6500)	11,574,230.00	331	533,509.00	333	11,040,721.00	335	4,555,065.00		337	6,485,656.00	339
5000 - Services... & (7000) Direct Support	21,473,984.00	341	618,903.00	343	20,855,081.00	345	3,080,755.00		347	17,774,326.00	349
TOTAL					221,040,931.00	365			TOTAL	203,088,845.00	369

Note 1 - In Column 2, report expenditures for the following programs: Nonagency (Goals 7100-7199), Community Services (Goal 8100), Food Services (Function 3700), Fringe Benefits for Retired Persons (Objects 3701-3702), and Facilities Acquisition & Construction (Function 8500).

Note 2 - In Column 4, report expenditures for: Transportation (Function 3600), Lottery Expenditures (Resource 1100), Special Education Students in Nonpublic Schools (Function 1180), and other federal or state categorical aid in which funds were granted for expenditures in a program not incurring any teacher salary expenditures or requiring disbursement of the funds without regard to the requirements of E.C. Section 41372.

Note 3 - If an amount (even zero) is entered in any row of Column 4b or in Line 13b, the form uses only the values in Column 4b and Line 13b rather than the values in Column 4a and Line 13a.

PART II: MINIMUM CLASSROOM COMPENSATION (Instruction, Functions 1000-1999)		Object	EDP No.
1. Teacher Salaries as Per E.C. 41011.		1100	95,884,219.00 375
2. Salaries of Instructional Aides Per E.C. 41011.		2100	7,063,724.00 380
3. STRS		3101 & 3102	7,759,822.00 382
4. PERS		3201 & 3202	512,581.00 383
5. OASDI - Regular, Medicare and Alternative.		3301 & 3302	1,724,175.00 384
6. Health & Welfare Benefits (E.C. 41372) (Include Health, Dental, Vision, Pharmaceutical, and Annuity Plans).		3401 & 3402	10,015,080.00 385
7. Unemployment Insurance.		3501 & 3502	51,519.00 390
8. Workers' Compensation Insurance.		3601 & 3602	2,806,663.00 392
9. OPEB, Active Employees (E.C. 41372).		3751 & 3752	0.00
10. Other Benefits (E.C. 22310).		3901 & 3902	1,449,269.00 393
11. SUBTOTAL Salaries and Benefits (Sum Lines 1 - 10).			127,267,052.00 395
12. Less: Teacher and Instructional Aide Salaries and Benefits deducted in Column 2.			1,426,194.00
13a. Less: Teacher and Instructional Aide Salaries and Benefits (other than Lottery) deducted in Column 4a (Extracted).			156,346.00 396
b. Less: Teacher and Instructional Aide Salaries and Benefits (other than Lottery) deducted in Column 4b (Overrides*).			396
14. TOTAL SALARIES AND BENEFITS.			125,684,512.00 397
15. Percent of Current Cost of Education Expended for Classroom Compensation (EDP 397 divided by EDP 369) Line 15 must equal or exceed 60% for elementary, 55% for unified and 50% for high school districts to avoid penalty under provision of E.C. 41372.			61.89%
16. District is exempt from E.C. 41372 because it meets the provisions under E.C. 41374. (If exempt, enter 'X')			

PART III: DEFICIENCY AMOUNT	
Deficiency amount (Line 5) is only applicable to districts not meeting the minimum classroom compensation percentage required under E.C. 41372 and not exempt under the provisions of E.C. 41374.	
1. Minimum percentage required (60% elementary, 55% unified, 50% high)	55.00%
2. Percentage spent by this district (Part II, Line 15)	61.89%
3. Percentage below the minimum (Part III, Line 1 minus Line 2)	0.00%
4. District's Current Expense of Education after reductions in columns 4a or 4b (Part I, EDP 369)	203,088,845.00
5. Deficiency Amount (Part III, Line 3 times Line 4)	0.00

Current Expense Formula/Minimum Classroom Compensation

PART I - CURRENT EXPENSE FORMULA	Total Expense for Year (1)	EDP No.	Reductions (See Note 1) (2)	EDP No.	Current Expense of Education (Col 1 - Col 2) (3)	EDP No.	Reductions (Extracted) (See Note 2) (4a)	Reductions (Overrides*) (See Note 2) (4b)	EDP No.	Current Expense-Part II (Col 3 - Col 4) (5)	EDP No.
300 - Certificated Salaries	119,383,893.00	301	1,641,497.00	303	117,742,396.00	305	3,611,374.00		307	114,131,022.00	309
2000 - Classified Salaries	37,971,343.00	311	653,935.00	313	37,317,408.00	315	4,939,800.00		317	32,377,608.00	319
300 - Employee Benefits (Excluding 3800)	44,800,945.00	321	7,235,142.00	323	37,565,803.00	325	2,362,594.00		327	35,203,209.00	329
4000 - Books, Supplies & Equip Replace. (6500)	15,359,765.00	331	388,400.00	333	14,971,365.00	335	7,651,779.00		337	7,319,586.00	339
5000 - Services... & (7000) Direct Support	22,849,073.00	341	372,234.00	343	22,476,839.00	345	2,341,315.00		347	20,135,524.00	349
TOTAL					230,073,811.00	365			TOTAL	209,166,949.00	369

Note 1 - In Column 2, report expenditures for the following programs: Nonagency (Goals 7100-7199), Community Services (Goal 8100), Food Services (Function 3700), Fringe Benefits for Retired Persons (Objects 3701-3702), and Facilities Acquisition & Construction (Function 8500).

Note 2 - In Column 4, report expenditures for: Transportation (Function 3600), Lottery Expenditures (Resource 1100), Special Education Students in Nonpublic Schools (Function 1180), and other federal or state categorical aid in which funds were granted for expenditures in a program not incurring any teacher salary expenditures or requiring disbursement of the funds without regard to the requirements of E.C. Section 41372.

* If an amount (even zero) is entered in any row of Column 4b or in Line 13b, the form uses only the values in Column 4b and Line 13b rather than the values in Column 4a and Line 13a.

PART II: MINIMUM CLASSROOM COMPENSATION (Instruction, Functions 1000-1999)		Object	EDP No.
1	Teacher Salaries as Per E.C. 41011	1100	375
2	Salaries of Instructional Aides Per E.C. 41011	2100	380
3	STRS	3101 & 3102	382
4	PERS	3201 & 3202	383
5	OASDI - Regular, Medicare and Alternative	3301 & 3302	384
6	Health & Welfare Benefits (E.C. 41372) (Include Health, Dental, Vision, Pharmaceutical, and Annuity Plans)	3401 & 3402	385
7	Unemployment Insurance	3501 & 3502	390
8	Workers' Compensation Insurance	3601 & 3602	392
9	OPEB, Active Employees (E.C. 41372)	3751 & 3752	393
10	Other Benefits (E.C. 22310)	3901 & 3902	393
11	SUBTOTAL Salaries and Benefits (Sum Lines 1 - 10)		395
12	Less: Teacher and Instructional Aide Salaries and Benefits deducted in Column 2		
13a	Less: Teacher and Instructional Aide Salaries and Benefits (other than Lottery) deducted in Column 4a (Extracted)		396
13b	Less: Teacher and Instructional Aide Salaries and Benefits (other than Lottery) deducted in Column 4b (Overrides*)		396
14	TOTAL SALARIES AND BENEFITS		397
15	Percent of Current Cost of Education Expended for Classroom Compensation (EDP 397 divided by EDP 369) Line 15 must equal or exceed 60% for elementary, 55% for unified and 50% for high school districts to avoid penalty under provision of E.C. 41372		60.82%
16	District is exempt from E.C. 41372 because it meets the provisions under E.C. 41374. (If exempt, enter 'X')		

PART III: DEFICIENCY AMOUNT	
Deficiency amount (Line 5) is only applicable to districts not meeting the minimum classroom compensation percentage required under E.C. 41372 and not exempt under the provisions of E.C. 41374.	
1	Minimum percentage required (60% elementary, 55% unified, 50% high)
2	Percentage spent by this district (Part II, Line 15)
3	Percentage below the minimum (Part III, Line 1 minus Line 2)
4	District's Current Expense of Education after reductions in columns 4a or 4b (Part I, EDP 369)
5	Deficiency Amount (Part III, Line 3 times Line 4)

July 1 Budget (Single Adoption)
2006-07 Estimated Actuals
SUMMARY OF INTERFUND ACTIVITIES
FOR ALL FUNDS

Description	Direct Costs-Interfund		Indirect/Direct Support Costs-Interfund		Interfund Transfers In 6910-6929	Interfund Transfers Out 7610-7629	Due From Other Funds 9310	Due To Other Funds 9610
	Transfers In 5750	Transfers Out 5750	Transfers In 7350, 7380	Transfers Out 7350, 7380				
01 GENERAL FUND								
Expenditure Detail	0.00	0.00	0.00	(426,613.00)				
Other Sources/Uses Detail					29,676.00	1,188,763.00		
Fund Reconciliation							0.00	0.00
CHARTER SCHOOLS SPECIAL REVENUE FUND								
Expenditure Detail	0.00	0.00	0.00	0.00				
Other Sources/Uses Detail					0.00	0.00		
Fund Reconciliation							0.00	0.00
11 ADULT EDUCATION FUND								
Expenditure Detail	0.00	0.00	1,863.00	0.00				
Other Sources/Uses Detail					0.00	0.00		
Fund Reconciliation							0.00	0.00
CHILD DEVELOPMENT FUND								
Expenditure Detail	0.00	0.00	141,664.00	0.00				
Other Sources/Uses Detail					0.00	0.00		
Fund Reconciliation							0.00	0.00
13 CAFETERIA SPECIAL REVENUE FUND								
Expenditure Detail	0.00	0.00	283,086.00	0.00				
Other Sources/Uses Detail					0.00	0.00		
Fund Reconciliation							0.00	0.00
DEFERRED MAINTENANCE FUND								
Expenditure Detail	0.00	0.00						
Other Sources/Uses Detail					1,911,952.00	0.00		
Fund Reconciliation							0.00	0.00
15 PUPIL TRANSPORTATION EQUIPMENT FUND								
Expenditure Detail	0.00	0.00						
Other Sources/Uses Detail					0.00	0.00		
Fund Reconciliation							0.00	0.00
SPECIAL RESERVE FUND FOR OTHER THAN CAPITAL OUTLAY								
Expenditure Detail								
Other Sources/Uses Detail					0.00	0.00		
Fund Reconciliation							0.00	0.00
18 SCHOOL BUS EMISSIONS REDUCTION FUND								
Expenditure Detail	0.00	0.00						
Other Sources/Uses Detail					0.00	0.00		
Fund Reconciliation							0.00	0.00
FOUNDATION SPECIAL REVENUE FUND								
Expenditure Detail	0.00	0.00						
Other Sources/Uses Detail					0.00	0.00		
Fund Reconciliation							0.00	0.00
20 SPECIAL RESERVE FUND FOR POSTEMPLOYMENT BENEFITS								
Expenditure Detail								
Other Sources/Uses Detail					0.00	0.00		
Fund Reconciliation							0.00	0.00
BUILDING FUND								
Expenditure Detail	0.00	0.00						
Other Sources/Uses Detail					0.00	0.00		
Fund Reconciliation							0.00	0.00
25 CAPITAL FACILITIES FUND								
Expenditure Detail	0.00	0.00	0.00					
Other Sources/Uses Detail					0.00	0.00		
Fund Reconciliation							0.00	0.00
STATE SCHOOL BUILDING LEASE/PURCHASE FUND								
Expenditure Detail	0.00	0.00						
Other Sources/Uses Detail					0.00	0.00		
Fund Reconciliation							0.00	0.00
25 COUNTY SCHOOL FACILITIES FUND								
Expenditure Detail	0.00	0.00						
Other Sources/Uses Detail					0.00	765,161.00		
Fund Reconciliation							0.00	0.00
20 SPECIAL RESERVE FUND FOR CAPITAL OUTLAY PROJECTS								
Expenditure Detail	0.00	0.00						
Other Sources/Uses Detail					41,972.00	29,676.00		
Fund Reconciliation							0.00	0.00
CAP PROJ FUND FOR BLENDED COMPONENT UNITS								
Expenditure Detail	0.00	0.00						
Other Sources/Uses Detail					0.00	0.00		
Fund Reconciliation							0.00	0.00
21 BOND INTEREST AND REDEMPTION FUND								
Expenditure Detail								
Other Sources/Uses Detail					0.00	0.00		
Fund Reconciliation							0.00	0.00
DEBT SVC FUND FOR BLENDED COMPONENT UNITS								
Expenditure Detail								
Other Sources/Uses Detail					0.00	0.00		
Fund Reconciliation							0.00	0.00
23 TAX OVERRIDE FUND								
Expenditure Detail								
Other Sources/Uses Detail					0.00	0.00		
Fund Reconciliation							0.00	0.00
DEBT SERVICE FUND								
Expenditure Detail								
Other Sources/Uses Detail					0.00	0.00		
Fund Reconciliation							0.00	0.00
27 FOUNDATION PERMANENT FUND								
Expenditure Detail	0.00	0.00						
Other Sources/Uses Detail					0.00	0.00		
Fund Reconciliation							0.00	0.00
CAFETERIA ENTERPRISE FUND								
Expenditure Detail	0.00	0.00	0.00	0.00				
Other Sources/Uses Detail					0.00	0.00		
Fund Reconciliation							0.00	0.00
26 CHARTER SCHOOLS ENTERPRISE FUND								
Expenditure Detail	0.00	0.00	0.00	0.00				
Other Sources/Uses Detail					0.00	0.00		
Fund Reconciliation							0.00	0.00

July 1 Budget (Single Adoption)
 2006-07 Estimated Actuals
 SUMMARY OF INTERFUND ACTIVITIES
 FOR ALL FUNDS

Description	Direct Costs-Interfund		Indirect/Direct Support Costs-Interfund		Interfund Transfers In 8910-8929	Interfund Transfers Out 7610-7629	Due From Other Funds 9310	Due To Other Funds 9610
	Transfers In 5750	Transfers Out 5750	Transfers In 7350, 7380	Transfers Out 7350, 7380				
63 OTHER ENTERPRISE FUND								
Expenditure Detail	0.00	0.00						
Other Sources/Uses Detail					0.00	0.00		
Fund Reconciliation							0.00	0.00
WAREHOUSE REVOLVING FUND								
Expenditure Detail	0.00	0.00						
Other Sources/Uses Detail					0.00	0.00		
Fund Reconciliation							0.00	0.00
67 SELF-INSURANCE FUND								
Expenditure Detail	0.00	0.00						
Other Sources/Uses Detail					0.00	0.00		
Fund Reconciliation							0.00	0.00
RETIREE BENEFIT FUND								
Expenditure Detail								
Other Sources/Uses Detail					0.00	0.00		
Fund Reconciliation							0.00	0.00
73 FOUNDATION PRIVATE-PURPOSE TRUST FUND								
Expenditure Detail	0.00	0.00						
Other Sources/Uses Detail					0.00	0.00		
Fund Reconciliation							0.00	0.00
WARRANT/PASS-THROUGH FUND								
Expenditure Detail								
Other Sources/Uses Detail								
Fund Reconciliation							0.00	0.00
75 STUDENT BODY FUND								
Expenditure Detail								
Other Sources/Uses Detail								
Fund Reconciliation							0.00	0.00
TOTALS	0.00	0.00	426,613.00	(426,613.00)	1,983,600.00	1,983,600.00	0.00	0.00

July 1 Budget (Single Adoption)
2007-08 Budget
SUMMARY OF INTERFUND ACTIVITIES
FOR ALL FUNDS

Description	Direct Costs-Interfund		Indirect/Direct Support Costs-Interfund		Interfund Transfers In 8910-8929	Interfund Transfers Out 7610-7629	Due From Other Funds 9310	Due To Other Funds 9610
	Transfers In 5750	Transfers Out 5750	Transfers In 7350, 7380	Transfers Out 7350, 7380				
01 GENERAL FUND								
Expenditure Detail	0.00	0.00	0.00	(146,040.00)				
Other Sources/Uses Detail					0.00	1,215,600.00		
Fund Reconciliation								
CHARTER SCHOOLS SPECIAL REVENUE FUND								
Expenditure Detail	0.00	0.00	0.00	0.00				
Other Sources/Uses Detail					0.00	0.00		
Fund Reconciliation								
11 ADULT EDUCATION FUND								
Expenditure Detail	0.00	0.00	397.00	0.00				
Other Sources/Uses Detail					0.00	0.00		
Fund Reconciliation								
CHILD DEVELOPMENT FUND								
Expenditure Detail	0.00	0.00	142,501.00	0.00				
Other Sources/Uses Detail					0.00	0.00		
Fund Reconciliation								
13 CAFETERIA SPECIAL REVENUE FUND								
Expenditure Detail	0.00	0.00	3,142.00	0.00				
Other Sources/Uses Detail					0.00	0.00		
Fund Reconciliation								
DEFERRED MAINTENANCE FUND								
Expenditure Detail	0.00	0.00						
Other Sources/Uses Detail					1,215,600.00	0.00		
Fund Reconciliation								
15 PUPIL TRANSPORTATION EQUIPMENT FUND								
Expenditure Detail	0.00	0.00						
Other Sources/Uses Detail					0.00	0.00		
Fund Reconciliation								
SPECIAL RESERVE FUND FOR OTHER THAN CAPITAL OUTLAY								
Expenditure Detail								
Other Sources/Uses Detail					0.00	0.00		
Fund Reconciliation								
18 SCHOOL BUS EMISSIONS REDUCTION FUND								
Expenditure Detail	0.00	0.00						
Other Sources/Uses Detail					0.00	0.00		
Fund Reconciliation								
FOUNDATION SPECIAL REVENUE FUND								
Expenditure Detail	0.00	0.00						
Other Sources/Uses Detail					0.00	0.00		
Fund Reconciliation								
20 SPECIAL RESERVE FUND FOR POSTEMPLOYMENT BENEFITS								
Expenditure Detail								
Other Sources/Uses Detail					0.00	0.00		
Fund Reconciliation								
BUILDING FUND								
Expenditure Detail	0.00	0.00						
Other Sources/Uses Detail					0.00	0.00		
Fund Reconciliation								
25 CAPITAL FACILITIES FUND								
Expenditure Detail	0.00	0.00	0.00					
Other Sources/Uses Detail					0.00	0.00		
Fund Reconciliation								
30 STATE SCHOOL BUILDING LEASE/PURCHASE FUND								
Expenditure Detail	0.00	0.00						
Other Sources/Uses Detail					0.00	0.00		
Fund Reconciliation								
35 COUNTY SCHOOL FACILITIES FUND								
Expenditure Detail	0.00	0.00						
Other Sources/Uses Detail					0.00	0.00		
Fund Reconciliation								
40 SPECIAL RESERVE FUND FOR CAPITAL OUTLAY PROJECTS								
Expenditure Detail	0.00	0.00						
Other Sources/Uses Detail					0.00	0.00		
Fund Reconciliation								
47 CAP PROJ FUND FOR BLENDED COMPONENT UNITS								
Expenditure Detail	0.00	0.00						
Other Sources/Uses Detail					0.00	0.00		
Fund Reconciliation								
51 BOND INTEREST AND REDEMPTION FUND								
Expenditure Detail								
Other Sources/Uses Detail					0.00	0.00		
Fund Reconciliation								
57 DEBT SVC FUND FOR BLENDED COMPONENT UNITS								
Expenditure Detail								
Other Sources/Uses Detail					0.00	0.00		
Fund Reconciliation								
63 TAX OVERRIDE FUND								
Expenditure Detail								
Other Sources/Uses Detail					0.00	0.00		
Fund Reconciliation								
67 DEBT SERVICE FUND								
Expenditure Detail								
Other Sources/Uses Detail					0.00	0.00		
Fund Reconciliation								
67 FOUNDATION PERMANENT FUND								
Expenditure Detail	0.00	0.00						
Other Sources/Uses Detail					0.00	0.00		
Fund Reconciliation								
CAFETERIA ENTERPRISE FUND								
Expenditure Detail	0.00	0.00	0.00	0.00				
Other Sources/Uses Detail					0.00	0.00		
Fund Reconciliation								
62 CHARTER SCHOOLS ENTERPRISE FUND								
Expenditure Detail	0.00	0.00	0.00	0.00				
Other Sources/Uses Detail					0.00	0.00		
Fund Reconciliation								

July 1 Budget (Single Adoption)
2007-08 Budget
SUMMARY OF INTERFUND ACTIVITIES
FOR ALL FUNDS

Description	Direct Costs-Interfund		Indirect/Direct Support Costs-Interfund		Interfund	Interfund	Due From Other Funds 9310	Due To Other Funds 9610
	Transfers In 5750	Transfers Out 5750	Transfers In 7350, 7380	Transfers Out 7350, 7380	Transfers In 8910-8929	Transfers Out 7610-7629		
63 OTHER ENTERPRISE FUND								
Expenditure Detail	0.00	0.00						
Other Sources/Uses Detail								
Fund Reconciliation					0.00	0.00		
WAREHOUSE REVOLVING FUND								
Expenditure Detail	0.00	0.00						
Other Sources/Uses Detail								
Fund Reconciliation					0.00	0.00		
67 SELF-INSURANCE FUND								
Expenditure Detail	0.00	0.00						
Other Sources/Uses Detail								
Fund Reconciliation					0.00	0.00		
RETIREE BENEFIT FUND								
Expenditure Detail								
Other Sources/Uses Detail					0.00	0.00		
Fund Reconciliation								
73 FOUNDATION PRIVATE-PURPOSE TRUST FUND								
Expenditure Detail	0.00	0.00						
Other Sources/Uses Detail								
Fund Reconciliation					0.00	0.00		
WARRANT/PASS-THROUGH FUND								
Expenditure Detail								
Other Sources/Uses Detail								
Fund Reconciliation								
65 STUDENT BODY FUND								
Expenditure Detail								
Other Sources/Uses Detail								
Fund Reconciliation								
TOTALS	0.00	0.00	146,040.00	(146,040.00)	1,215,600.00	1,215,600.00		

July 1 Budget (Single Adoption)
2006-07 Estimated Actuals
Schedule of Capital Assets

Orange Unified
Orange County

	Unaudited Balance July 1	Audit Adjustments/ Restatements	Audited Balance July 1	Increases	Decreases	Ending Balance June 30
Governmental Activities:						
Capital assets not being depreciated:						
Land	19,687,697.00		19,687,697.00			19,687,697.00
Work in Progress	3,033,520.00		3,033,520.00		714,262.00	2,319,258.00
Total capital assets not being depreciated	22,721,217.00	0.00	22,721,217.00	0.00	714,262.00	22,006,955.00
Capital assets being depreciated:						
Land Improvements	11,720,094.00		11,720,094.00	1,352,980.00		13,073,074.00
Buildings	76,582,815.00		76,582,815.00	4,694,438.00		81,277,253.00
Equipment	15,526,204.00		15,526,204.00		1,823,048.00	13,703,156.00
Total capital assets being depreciated	103,829,113.00	0.00	103,829,113.00	6,047,418.00	1,823,048.00	108,053,483.00
Accumulated Depreciation for:						
Land Improvements	(8,517,502.00)		(8,517,502.00)	316,802.00		(8,200,700.00)
Buildings	(43,796,460.00)		(43,796,460.00)	1,628,990.00		(42,167,470.00)
Equipment	(10,175,537.00)		(10,175,537.00)	378,479.00		(9,797,058.00)
Total accumulated depreciation	(62,489,499.00)	0.00	(62,489,499.00)	2,324,271.00	0.00	(60,165,228.00)
Total capital assets being depreciated, net	41,339,614.00	0.00	41,339,614.00	8,371,689.00	1,823,048.00	47,888,255.00
Governmental activity capital assets, net	64,060,831.00	0.00	64,060,831.00	8,371,689.00	2,537,310.00	69,895,210.00
Business-Type Activities:						
Capital assets not being depreciated:						
Land			0.00			0.00
Work in Progress			0.00			0.00
Total capital assets not being depreciated	0.00	0.00	0.00	0.00	0.00	0.00
Capital assets being depreciated:						
Land Improvements			0.00			0.00
Buildings			0.00			0.00
Equipment			0.00			0.00
Total capital assets being depreciated	0.00	0.00	0.00	0.00	0.00	0.00
Accumulated Depreciation for:						
Land Improvements			0.00			0.00
Buildings			0.00			0.00
Equipment			0.00			0.00
Total accumulated depreciation	0.00	0.00	0.00	0.00	0.00	0.00
Total capital assets being depreciated, net	0.00	0.00	0.00	0.00	0.00	0.00
Business-type activity capital assets, net	0.00	0.00	0.00	0.00	0.00	0.00

Description	Resource Codes	Object Codes	2006-07 Estimated Actuals			2007-08 Budget			% Diff Column C & F
			Unrestricted (A)	Restricted (B)	Total Fund col. A + B (C)	Unrestricted (D)	Restricted (E)	Total Fund col. D + E (F)	
A. REVENUES									
Revenue Limit Sources		8010-8099	155,090,075.00	5,559,712.00	160,649,787.00	155,212,625.00	5,810,504.00	161,023,129.00	0.2%
Federal Revenue		8100-8299	1,455.00	14,984,952.00	14,986,407.00	0.00	13,130,286.00	13,130,286.00	-12.3%
3) Other State Revenue		8300-8599	14,538,699.00	43,013,263.00	57,551,962.00	14,867,817.00	37,381,788.00	52,249,605.00	-9.2%
Other Local Revenue		8600-8799	8,037,338.00	6,649,584.00	14,686,922.00	3,837,923.00	5,060,159.00	8,898,082.00	-39.4%
TOTAL REVENUES			177,667,567.00	70,187,511.00	247,855,078.00	173,918,365.00	61,382,737.00	235,301,102.00	-5.1%
B. EXPENDITURES									
1) Certificated Salaries		1000-1999	89,317,008.00	26,475,175.00	115,792,183.00	92,045,778.00	27,338,115.00	119,383,893.00	3.1%
Classified Salaries		2000-2999	19,144,892.00	17,417,613.00	36,562,605.00	19,260,335.00	18,711,008.00	37,971,343.00	3.9%
Employee Benefits		3000-3999	35,186,606.00	11,411,413.00	46,598,019.00	33,460,808.00	12,277,145.00	45,737,953.00	-1.8%
4) Books and Supplies		4000-4999	1,607,330.00	9,881,835.00	11,489,165.00	3,743,812.00	11,556,953.00	15,300,765.00	33.2%
Services and Other Operating Expenditures		5000-5999	9,771,516.00	12,129,081.00	21,900,597.00	10,689,108.00	12,306,005.00	22,995,113.00	5.0%
6) Capital Outlay		6000-6999	275,814.00	1,174,440.00	1,450,254.00	25,000.00	225,000.00	250,000.00	-82.8%
7) Other Outgo (excluding Transfers of Indirect/ Direct Support Costs)		7100-7299 7400-7499	8,215,409.00	1,690,824.00	9,906,233.00	46,988.00	2,743,137.00	2,790,125.00	-71.8%
8) Transfers of Indirect/Direct Support Costs		7300-7399	(3,416,804.00)	2,990,191.00	(426,613.00)	(1,961,185.00)	1,815,145.00	(146,040.00)	-65.8%
TOTAL EXPENDITURES			160,101,871.00	83,170,572.00	243,272,443.00	157,310,644.00	86,972,508.00	244,283,152.00	0.4%
C. EXCESS (DEFICIENCY) OF REVENUES OVER EXPENDITURES BEFORE OTHER FINANCING SOURCES AND USES (A5 - B9)									
			17,565,696.00	(12,983,061.00)	4,582,635.00	16,607,721.00	(25,589,771.00)	(8,982,050.00)	-296.0%
D. OTHER FINANCING SOURCES/USES									
Interfund Transfers									
a) Transfers In		8910-8920	29,676.00	0.00	29,676.00	0.00	0.00	0.00	-100.0%
b) Transfers Out		7610-7629	20,935.00	1,167,828.00	1,188,763.00	0.00	1,215,600.00	1,215,600.00	2.3%
Other Sources/Uses									
a) Sources		8930-8979	0.00	0.00	0.00	0.00	0.00	0.00	0.0%
b) Uses		7630-7699	0.00	0.00	0.00	0.00	0.00	0.00	0.0%
3) Contributions		8980-8999	(18,149,782.00)	18,149,782.00	0.00	(20,451,741.00)	20,451,741.00	0.00	0.0%
TOTAL OTHER FINANCING SOURCES/USES			(18,141,041.00)	16,981,954.00	(1,159,087.00)	(20,451,741.00)	19,236,141.00	(1,215,600.00)	4.9%

Description	Resource Codes	Object Codes	2006-07 Estimated Actuals			2007-08 Budget			% Diff Column C & F
			Unrestricted (A)	Restricted (B)	Total Fund col. A + B (C)	Unrestricted (D)	Restricted (E)	Total Fund col. D + E (F)	
E. NET INCREASE (DECREASE) IN FUND BALANCE (C + D4)									
			(575,345.00)	3,998,893.00	3,423,548.00	(3,844,020.00)	(6,353,630.00)	(10,197,650.00)	-397.9%
F. FUND BALANCE, RESERVES									
Beginning Fund Balance									
a) As of July 1 - Unaudited		9791	19,352,890.65	2,354,737.00	21,707,627.65	18,777,545.65	6,353,630.00	25,131,175.65	15.8%
b) Audit Adjustments		9793	0.00	0.00	0.00	0.00	0.00	0.00	0.0%
c) As of July 1 - Audited (F1a + F1b)			19,352,890.65	2,354,737.00	21,707,627.65	18,777,545.65	6,353,630.00	25,131,175.65	15.8%
d) Other Restatements		9785	0.00	0.00	0.00	0.00	0.00	0.00	0.0%
e) Adjusted Beginning Balance (F1c + F1d)			19,352,890.65	2,354,737.00	21,707,627.65	18,777,545.65	6,353,630.00	25,131,175.65	15.8%
f) Ending Balance, June 30 (E + F1e)			18,777,545.65	6,353,630.00	25,131,175.65	14,933,525.65	0.00	14,933,525.65	-40.6%
Components of Ending Fund Balance									
i) Reserve for									
Revolving Cash		9711	125,000.00	0.00	125,000.00	125,000.00	0.00	125,000.00	0.0%
Stores		9712	137,676.85	0.00	137,676.85	140,000.00	0.00	140,000.00	1.7%
Prepaid Expenditures		9713	0.00	0.00	0.00	0.00	0.00	0.00	0.0%
All Others		9719	0.00	0.00	0.00	0.00	0.00	0.00	0.0%
General Reserve		9730	0.00	0.00	0.00	0.00	0.00	0.00	0.0%
Legally Restricted Balance		9740	0.00	0.00	0.00	0.00	0.00	0.00	0.0%
p) Designated Amounts									
Designated for Economic Uncertainties									
Designated for the Unrealized Gains of Investments and Cash in County Treasury		9770	7,333,836.00	0.00	7,333,836.00	7,364,963.00	0.00	7,364,963.00	0.4%
Other Designations		9780	1,291,491.00	6,353,630.00	7,645,121.00	456,127.00	0.00	456,127.00	-94.0%
El Rancho Beginning Balance	0000	9780				400,000.00		400,000.00	
Non-Resident Tuition	0000	9780				56,127.00		56,127.00	
El Rancho Beginning Balance	0000	9780	625,118.00		625,118.00				
Non-Resident Tuition	0000	9780	56,127.00		56,127.00				
School Site API Grant Awards	0000	9780	24,350.00		24,350.00				
School Site Carryover	0000	9780	268,817.00		268,817.00				
School Site/Department Donations	0000	9780	317,079.00		317,079.00				
English Language Acquisition	6286	9780		148,787.00	148,787.00				
Career Tech Equip/Supplies	6377	9780		167,127.00	167,127.00				
School Safety	6405	9780		59,093.00	59,093.00				
Arts, Music PE Supplies/Equip	6761	9780		1,424,680.00	1,424,680.00				
CAHSEE Intensive Instruction	7055	9780		12,083.00	12,083.00				
CAHSEE Materials	7056	9780		4,738.00	4,738.00				
School Counseling	7080	9780		255,214.00	255,214.00				
School Counseling-El Rancho	7080	9780		69,026.00	69,026.00				
EIA	7091	9780		609,760.00	609,760.00				
Instructional Materials	7156	9780		893,038.00	893,038.00				
Instructional Materials - Williams	7158	9780		118,099.00	118,099.00				
PAR	7271	9780		91,606.00	91,606.00				
Staff Development Math/Reading	7294	9780		91,130.00	91,130.00				
Principals' Training AB75	7325	9780		17,558.00	17,558.00				
Pupil Retention Block Grant	7390	9780		129,460.00	129,460.00				
Teacher Credentialing Block	7392	9780		244,833.00	244,833.00				
School Library Improvement Block	7395	9780		369,120.00	369,120.00				
School Site Discretionary Block	7396	9780		1,079,744.00	1,079,744.00				
District Discretionary Block	7397	9780		391,583.00	391,583.00				
Instructional Matl, Library and Ed Tech	7398	9780		176,951.00	176,951.00				
c) Undesignated Amount		9780	9,889,541.80	0.00	9,889,541.80				
d) Unappropriated Amount		9780				6,847,435.65	0.00	6,847,435.65	

Description	Resource Codes	Object Codes	2006-07 Estimated Actuals			2007-08 Budget			% Diff Column C & F
			Unrestricted (A)	Restricted (B)	Total Fund col. A + B (C)	Unrestricted (D)	Restricted (E)	Total Fund col. D + E (F)	
REVENUE LIMIT SOURCES									
Municipal Apportionment		8011	45,507,069.00	0.00	45,507,069.00	46,045,248.00	0.00	46,045,248.00	1.2%
State Aid - Current Year		8015	1,897,979.00	0.00	1,897,979.00	1,948,476.00	0.00	1,948,476.00	2.7%
Charter Schools General Purpose Entitlement - State Aid		8019	(34,816.00)	0.00	(34,816.00)	0.00	0.00	0.00	-100.0%
State Aid - Prior Years		8021	1,034,704.00	0.00	1,034,704.00	1,034,704.00	0.00	1,034,704.00	0.0%
Tax Relief Subventions Homeowners' Exemptions		8022	0.00	0.00	0.00	0.00	0.00	0.00	0.0%
Timber Yield Tax		8029	50.00	0.00	50.00	50.00	0.00	50.00	0.0%
Other Subventions/In-Lieu Taxes		8041	98,718,097.00	0.00	98,718,097.00	103,388,319.00	0.00	103,388,319.00	4.7%
County & District Taxes Secured Roll Taxes		8042	4,709,131.00	0.00	4,709,131.00	4,709,131.00	0.00	4,709,131.00	0.0%
Unsecured Roll Taxes		8043	2,638,639.00	0.00	2,638,639.00	2,638,639.00	0.00	2,638,639.00	0.0%
Prior Years' Taxes		8044	4,943,955.00	0.00	4,943,955.00	4,202,362.00	0.00	4,202,362.00	-15.0%
Supplemental Taxes		8045	201,977.00	0.00	201,977.00	201,977.00	0.00	201,977.00	0.0%
Education Revenue Augmentation Fund (ERAF)		8047	4,137.00	0.00	4,137.00	4,137.00	0.00	4,137.00	0.0%
Community Redevelopment Funds (B 617/699/1992)		8048	0.00	0.00	0.00	0.00	0.00	0.00	0.0%
Fees and Interest on Delinquent Revenue Limit Taxes		8081	0.00	0.00	0.00	0.00	0.00	0.00	0.0%
Miscellaneous Funds (EC 41604) Royalties and Bonuses		8082	0.00	0.00	0.00	0.00	0.00	0.00	0.0%
Other In-Lieu Taxes		8089	0.00	0.00	0.00	0.00	0.00	0.00	0.0%
Less: Non-Revenue Limit (50%) Adjustment									
Total, Revenue Limit Sources			159,620,922.00	0.00	159,620,922.00	164,173,043.00	0.00	164,173,043.00	2.9%
REVENUE LIMIT TRANSFERS									
Unrestricted Revenue Limit Transfers - Current Year	0000	8091	(5,559,712.00)		(5,559,712.00)	(5,810,504.00)		(5,810,504.00)	4.5%
Continuation Education ADA Transfer	2200	8091		0.00	0.00		0.00	0.00	0.0%
Community Day Schools Transfer	2430	8091		0.00	0.00		0.00	0.00	0.0%
Social Education ADA Transfer	6500	8091		5,559,712.00	5,559,712.00		5,810,504.00	5,810,504.00	4.5%
ROC/P Apprentice Hours Transfer	6350	8091		0.00	0.00		0.00	0.00	
Other Revenue Limit Transfers - Current Year	All Other	8091	0.00	0.00	0.00	0.00	0.00	0.00	0.0%
IRS Reduction Transfer		8092	1,028,865.00	0.00	1,028,865.00	1,060,910.00	0.00	1,060,910.00	3.1%
Transfers to Charter Schools in Lieu of Property Taxes		8096				(4,210,824.00)	0.00	(4,210,824.00)	
Property Taxes Transfers		8097	0.00	0.00	0.00	0.00	0.00	0.00	0.0%
Revenue Limit Transfers - Prior Years		8099	0.00	0.00	0.00	0.00	0.00	0.00	0.0%
TOTAL, REVENUE LIMIT SOURCES			155,090,075.00	5,559,712.00	160,649,787.00	155,212,625.00	5,810,504.00	161,023,129.00	0.2%
FEDERAL REVENUE									
Maintenance and Operations		8110	0.00	0.00	0.00	0.00	0.00	0.00	0.0%
Social Education Entitlement		8181	0.00	4,978,314.00	4,978,314.00	0.00	4,978,314.00	4,978,314.00	0.0%
Social Education Discretionary Grants		8182	0.00	478,567.00	478,567.00	0.00	469,148.00	469,148.00	-2.0%
Child Nutrition Programs		8220	0.00	0.00	0.00	0.00	0.00	0.00	0.0%
Trust Reserve Funds		8260	0.00	0.00	0.00	0.00	0.00	0.00	0.0%
Flood Control Funds		8270	0.00	0.00	0.00	0.00	0.00	0.00	0.0%
Wildlife Reserve Funds		8280	0.00	0.00	0.00	0.00	0.00	0.00	0.0%
1A		8281	0.00	0.00	0.00	0.00	0.00	0.00	0.0%
Interagency Contracts Between LEAs		8285	0.00	0.00	0.00	0.00	0.00	0.00	0.0%
Fees-Through Revenues from Federal Sources		8287	0.00	0.00	0.00	0.00	0.00	0.00	0.0%
IB/ASA	3000-3299, 4000- 4139, 4201-4215, 4610, 5510	8290		8,711,459.00	8,711,459.00		7,022,141.00	7,022,141.00	-19.4%
Vocational and Applied Technology Education	3500-3699	8290		215,693.00	215,693.00		211,334.00	211,334.00	-2.0%
Safe and Drug Free Schools	3700-3799	8290		156,402.00	156,402.00		105,572.00	105,572.00	-32.5%
JTPA / WIA	5600-5625	8290		0.00	0.00		0.00	0.00	0.0%
Other Federal Revenue	All Other	8290	1,455.00	424,517.00	425,972.00	0.00	343,777.00	343,777.00	-19.3%
TOTAL, FEDERAL REVENUE			1,455.00	14,964,952.00	14,966,407.00	0.00	13,130,286.00	13,130,286.00	-12.3%

Description	Resource Codes	Object Codes	2006-07 Estimated Actuals			2007-08 Budget			% Diff Column C & F
			Unrestricted (A)	Restricted (B)	Total Fund col. A + B (C)	Unrestricted (D)	Restricted (E)	Total Fund col. D + E (F)	
OTHER STATE REVENUE									
Other State Apportionments									
Supplemental Instruction Programs									
Current Year	0000	8311				1,979,852.00		1,979,852.00	
Prior Years	0000	8319				0.00		0.00	
Community Day School Additional Funding									
Current Year	2430	8311					0.00	0.00	
Prior Years	2430	8319					0.00	0.00	
C/P Entitlement									
Current Year	6350-6360	8311		0.00	0.00		0.00	0.00	0.0%
Prior Years	6360-6360	8319		0.00	0.00		0.00	0.00	0.0%
Special Education Master Plan									
Current Year	6500	8311		17,290,324.00	17,290,324.00		17,638,472.00	17,638,472.00	2.0%
Prior Years	6500	8319		3,531.00	3,531.00		0.00	0.00	-100.0%
Gifted and Talented Pupils	7140	8311		246,174.00	246,174.00		256,322.00	256,322.00	4.1%
Home-to-School Transportation	7230	8311		1,896,454.00	1,896,454.00		1,982,364.00	1,982,364.00	4.5%
School Improvement Program	7260-7266	8311		0.00	0.00		0.00	0.00	0.0%
Economic Impact Aid	7090-7091	8311		3,334,494.00	3,334,494.00		3,485,547.00	3,485,547.00	4.5%
Spec. Ed. Transportation	7240	8311		664,921.00	664,921.00		695,042.00	695,042.00	4.5%
All Other State Apportionments - Current Year	All Other	8311	0.00	0.00	0.00	0.00	0.00	0.00	0.0%
All Other State Apportionments - Prior Years	All Other	8319	0.00	0.00	0.00	0.00	0.00	0.00	0.0%
Star Round School Incentive		8425	0.00	0.00	0.00	0.00	0.00	0.00	0.0%
Class Size Reduction, K-3		8434	7,568,896.00	0.00	7,568,896.00	7,811,767.00	0.00	7,811,767.00	3.2%
Class Size Reduction, Grade Nine		8436	883,320.00	0.00	883,320.00	919,518.00	0.00	919,518.00	4.1%
Charter Schools Categorical Block Grant		8480	385,551.00	0.00	385,551.00	481,938.00	0.00	481,938.00	25.0%
Child Nutrition Programs		8520	0.00	0.00	0.00	0.00	0.00	0.00	0.0%
Indicated Costs Reimbursements		8550	1,940,904.00	0.00	1,940,904.00	0.00	0.00	0.00	-100.0%
State Lottery Revenue		8560	3,501,650.00	583,825.00	4,085,475.00	3,424,887.00	556,364.00	3,981,251.00	-2.1%
Tax Relief Subventions									
Restricted Levies - Other									
Homeowners' Exemptions		8575	0.00	0.00	0.00	0.00	0.00	0.00	0.0%
Other Subventions/n-Lieu Taxes		8576	0.00	0.00	0.00	0.00	0.00	0.00	0.0%
Pass-Through Revenues from State Sources		8587	0.00	0.00	0.00	0.00	0.00	0.00	0.0%
Arts and Music Block Grant	8760	8590		480,890.00	480,890.00		500,318.00	500,318.00	4.0%
Miller Unruh Reading Program	7200	8590		0.00	0.00		0.00	0.00	0.0%
Home Program, Reading & Math	7050	8590		0.00	0.00		0.00	0.00	0.0%
Supplemental School Counseling Program	7080	8590		878,696.00	878,696.00		914,195.00	914,195.00	4.0%
Instructional Materials	7155, 7156, 7157, 7158, 7160, 7170, 7180	8590		1,895,404.00	1,895,404.00		1,884,939.00	1,884,939.00	-0.6%
Staff Development	7292, 7294, 7295, 7296, 7305	8590		161,250.00	161,250.00		0.00	0.00	-100.0%
Elementary Grade Counseling	7375	8590		0.00	0.00		0.00	0.00	0.0%
Educational Technology Assistance Grants	7100-7125	8590		0.00	0.00		0.00	0.00	0.0%
School Based Coordination Program	7250	8590		0.00	0.00		0.00	0.00	0.0%
Drug/Alcohol/Tobacco Funds	6605-6680	8590		53,786.00	53,786.00		44,878.00	44,878.00	-16.6%
Healthy Start	6240-6245	8590		0.00	0.00		0.00	0.00	0.0%
Class Size Reduction Facilities	6200	8590		0.00	0.00		0.00	0.00	0.0%
upil Retention Block Grant	7390	8590		83,628.00	83,628.00		86,667.00	86,667.00	3.6%
School Community Violence Prevention Grant	7391	8590		0.00	0.00		0.00	0.00	0.0%
Teacher Credentialing Block Grant	7392	8590		444,889.00	444,889.00		375,800.00	375,800.00	-15.5%
Professional Development Block Grant	7393	8590		1,561,017.00	1,561,017.00		1,625,367.00	1,625,367.00	4.1%
Targeted Instructional Improvement Block Grant	7394	8590		1,855,608.00	1,855,608.00		1,932,102.00	1,932,102.00	4.1%
School and Library Improvement Block Grant	7395	8590		2,182,504.00	2,182,504.00		2,272,474.00	2,272,474.00	4.1%
Quality Education Investment Act	7400	8590					0.00	0.00	
All Other State Revenue	All Other	8590	259,378.00	9,415,868.00	9,674,246.00	249,855.00	3,130,936.00	3,380,791.00	-65.1%
TOTAL, OTHER STATE REVENUE			14,538,699.00	43,013,263.00	57,551,962.00	14,867,817.00	37,381,788.00	52,249,605.00	-9.2%

Description	Resource Codes	Object Codes	2006-07 Estimated Actuals			2007-08 Budget			% Diff Column C & F
			Unrestricted (A)	Restricted (B)	Total Fund col. A + B (C)	Unrestricted (D)	Restricted (E)	Total Fund col. D + E (F)	
OTHER LOCAL REVENUE									
Charter Local Revenue									
County and District Taxes									
Other Restricted Levies									
Secured Roll		8615	0.00	0.00	0.00	0.00	0.00	0.00	0.0%
Unsecured Roll		8616	0.00	0.00	0.00	0.00	0.00	0.00	0.0%
Prior Years' Taxes		8617	0.00	0.00	0.00	0.00	0.00	0.00	0.0%
Supplemental Taxes		8618	0.00	0.00	0.00	0.00	0.00	0.00	0.0%
Non-Ad Valorem Taxes									
Parcel Taxes		8621	0.00	0.00	0.00	0.00	0.00	0.00	0.0%
Other		8622	0.00	0.00	0.00	0.00	0.00	0.00	0.0%
Community Redevelopment Funds									
Not Subject to RL Deduction		8625	612,857.00	0.00	612,857.00	550,000.00	0.00	550,000.00	-10.3%
Fines and Interest from Delinquent Non-Revenue									
Permit Taxes		8629	0.00	0.00	0.00	0.00	0.00	0.00	0.0%
Sales									
Sale of Equipment/Supplies		8631	9,369.00	0.00	9,369.00	0.00	0.00	0.00	-100.0%
Sale of Publications		8632	0.00	0.00	0.00	0.00	0.00	0.00	0.0%
Food Service Sales		8634	0.00	0.00	0.00	0.00	0.00	0.00	0.0%
All Other Sales		8639	0.00	0.00	0.00	0.00	0.00	0.00	0.0%
Leases and Rentals		8650	182,538.00	0.00	182,538.00	185,000.00	0.00	185,000.00	1.3%
Interest		8660	1,866,334.00	70,446.00	1,936,780.00	1,809,911.00	60,089.00	1,870,000.00	-3.4%
Net Increase (Decrease) in the Fair Value of Investments		8662	0.00	0.00	0.00	0.00	0.00	0.00	0.0%
Fees and Contracts									
Non-Resident Students		8672	0.00	0.00	0.00	0.00	0.00	0.00	0.0%
Transportation Fees From Individuals		8675	0.00	253,813.00	253,813.00	0.00	260,000.00	260,000.00	2.4%
Transportation Services	7230, 7240	8677	0.00	0.00	0.00	0.00	0.00	0.00	0.0%
Interagency Services	All Other	8677	0.00	5,055,198.00	5,055,198.00	0.00	4,517,055.00	4,517,055.00	-10.6%
Litigation/Developer Fees		8681	0.00	0.00	0.00	0.00	0.00	0.00	0.0%
All Other Fees and Contracts		8689	381,879.00	0.00	381,879.00	403,146.00	0.00	403,146.00	5.6%
Other Local Revenue									
Includes: Misc Funds Non-Revenue									
Limit (50%) Adjustment		8691	0.00	0.00	0.00	0.00	0.00	0.00	0.0%
Pass-Through Revenues From Local Sources		8697	0.00	0.00	0.00	0.00	0.00	0.00	0.0%
All Other Local Revenue		8699	383,528.00	1,085,665.00	1,469,193.00	383,522.00	31,284.00	414,806.00	-71.8%
Tuition		8710	450,078.00	0.00	450,078.00	506,344.00	0.00	506,344.00	12.5%
Transfers from Sponsoring LEAs to Charter Schools in Lieu of Property Taxes		8780	4,150,755.00	0.00	4,150,755.00				
All Other Transfers In		8781-8783	0.00	0.00	0.00	0.00	0.00	0.00	0.0%
Transfers of Apportionments									
Special Education SELPA Transfers									
From Districts or Charter Schools	6500	8791		184,462.00	184,462.00		191,731.00	191,731.00	3.9%
From County Offices	6500	8792		0.00	0.00		0.00	0.00	0.0%
From JPAs	6500	8793		0.00	0.00		0.00	0.00	0.0%
ROC/P Transfers									
From Districts or Charter Schools	6350, 6360	8791		0.00	0.00		0.00	0.00	0.0%
From County Offices	6350, 6360	8792		0.00	0.00		0.00	0.00	0.0%
From JPAs	6350, 6360	8793		0.00	0.00		0.00	0.00	0.0%
Other Transfers of Apportionments									
From Districts or Charter Schools	All Other	8791	0.00	0.00	0.00	0.00	0.00	0.00	0.0%
From County Offices	All Other	8792	0.00	0.00	0.00	0.00	0.00	0.00	0.0%
From JPAs	All Other	8793	0.00	0.00	0.00	0.00	0.00	0.00	0.0%
All Other Transfers In From All Others		8799	0.00	0.00	0.00	0.00	0.00	0.00	0.0%
TOTAL OTHER LOCAL REVENUE			8,037,338.00	6,649,584.00	14,686,922.00	3,837,923.00	5,060,159.00	8,898,082.00	-39.4%
TOTAL REVENUES			177,667,567.00	70,187,511.00	247,855,078.00	173,918,365.00	61,382,737.00	235,301,102.00	-5.1%

Description	Resource Codes	Object Codes	2006-07 Estimated Actuals			2007-08 Budget			% Diff Column C & F
			Unrestricted (A)	Restricted (B)	Total Fund col. A + B (C)	Unrestricted (D)	Restricted (E)	Total Fund col. D + E (F)	
CERTIFICATED SALARIES									
Teachers' Salaries		1100	74,334,724.00	22,096,898.00	96,431,622.00	77,329,832.00	22,180,823.00	89,510,655.00	3.2%
Certificated Pupil Support Salaries		1200	5,370,971.00	1,143,294.00	6,514,265.00	5,508,853.00	1,761,726.00	7,270,589.00	11.6%
Certificated Supervisors' and Administrators' Salaries		1300	8,839,522.00	2,683,782.00	11,523,304.00	8,414,656.00	3,049,621.00	11,464,287.00	-0.5%
Senior Certificated Salaries		1900	771,791.00	551,201.00	1,322,992.00	792,417.00	345,945.00	1,138,362.00	-14.0%
TOTAL, CERTIFICATED SALARIES			89,317,008.00	26,475,175.00	115,792,183.00	92,045,778.00	27,338,115.00	119,383,893.00	3.1%
CLASSIFIED SALARIES									
Instructional Aides' Salaries		2100	442,902.00	6,959,368.00	7,402,270.00	453,777.00	7,260,334.00	7,714,111.00	4.2%
Classified Support Salaries		2200	8,888,359.00	6,035,558.00	14,923,917.00	8,812,700.00	6,717,559.00	15,530,259.00	4.1%
Classified Supervisors' and Administrators' Salaries		2300	1,801,544.00	1,200,065.00	3,001,609.00	1,979,093.00	1,324,898.00	3,303,991.00	10.1%
Clerical, Technical and Office Salaries		2400	7,764,157.00	3,204,788.00	10,968,945.00	7,741,715.00	3,401,217.00	11,142,932.00	1.6%
Senior Classified Salaries		2900	248,030.00	17,834.00	265,864.00	273,050.00	7,000.00	280,050.00	5.3%
TOTAL, CLASSIFIED SALARIES			19,144,992.00	17,417,613.00	36,562,605.00	19,260,335.00	18,711,008.00	37,971,343.00	3.9%
EMPLOYEE BENEFITS									
STRS		3101-3102	7,265,903.00	2,184,911.00	9,450,814.00	7,607,616.00	2,180,241.00	9,787,857.00	3.6%
DIS		3201-3202	2,716,444.00	1,803,676.00	4,520,120.00	2,701,557.00	2,034,714.00	4,736,271.00	4.8%
CASDI/Medicare/Alternative		3301-3302	2,525,692.00	1,500,981.00	4,026,673.00	2,820,846.00	1,570,413.00	4,391,259.00	9.1%
Health and Welfare Benefits		3401-3402	11,346,122.00	4,263,603.00	15,609,725.00	11,643,838.00	4,830,887.00	16,474,725.00	5.5%
Employment Insurance		3501-3502	44,312.00	22,739.00	67,051.00	55,957.00	23,127.00	79,084.00	17.9%
Workers' Compensation		3601-3602	2,469,887.00	1,138,661.00	3,608,548.00	1,823,932.00	756,733.00	2,580,665.00	-28.5%
CEB, Allocated		3701-3702	5,934,371.00	175,364.00	6,109,735.00	6,154,561.00	530,650.00	6,685,211.00	9.4%
CEB, Active Employees		3751-3752				0.00	0.00	0.00	
PERS Reduction		3801-3802	589,390.00	321,478.00	910,868.00	586,628.00	350,380.00	937,008.00	2.9%
Senior Employee Benefits		3901-3902	2,294,485.00	0.00	2,294,485.00	65,873.00	0.00	65,873.00	-97.1%
TOTAL, EMPLOYEE BENEFITS			35,186,606.00	11,411,413.00	46,598,019.00	33,460,808.00	12,277,145.00	45,737,953.00	-1.8%
BOOKS AND SUPPLIES									
Approved Textbooks and Core Curricula Materials		4100	87,971.00	2,201,428.00	2,289,399.00	2,281.00	2,139,734.00	2,142,015.00	-6.4%
Books and Other Reference Materials		4200	27,660.00	258,240.00	285,900.00	16,460.00	78,265.00	94,725.00	-66.9%
Materials and Supplies		4300	1,221,785.00	5,336,161.00	6,557,946.00	3,469,905.00	8,637,155.00	12,107,060.00	84.6%
Noncapitalized Equipment		4400	269,914.00	2,086,006.00	2,355,920.00	255,166.00	701,799.00	956,965.00	-59.4%
Gifted		4700	0.00	0.00	0.00	0.00	0.00	0.00	0.0%
TOTAL, BOOKS AND SUPPLIES			1,607,330.00	9,881,835.00	11,489,165.00	3,743,812.00	11,556,953.00	15,300,765.00	33.2%
SERVICES AND OTHER OPERATING EXPENDITURES									
Coagreements for Services		5100				0.00	0.00	0.00	
Travel and Conferences		5200	197,228.00	737,605.00	934,833.00	200,970.00	363,418.00	564,388.00	-39.6%
Dues and Memberships		5300	91,139.00	5,447.00	96,586.00	85,825.00	3,000.00	88,825.00	-8.0%
Insurance		5400 - 5450	897,478.00	68,850.00	966,328.00	931,150.00	68,850.00	1,000,000.00	3.5%
Operations and Housekeeping Services		5500	4,821,640.00	12,390.00	4,834,030.00	4,864,658.00	11,242.00	4,875,900.00	0.9%
Utilities, Leases, Repairs, and Noncapitalized Improvements		5600	1,163,820.00	1,888,263.00	3,052,083.00	1,173,944.00	3,953,141.00	5,127,085.00	68.0%
Transfers of Direct Costs		5710	900,000.00	(900,000.00)	0.00	900,000.00	(900,000.00)	0.00	0.0%
Transfers of Direct Costs - Interfund		5750	0.00	0.00	0.00	0.00	0.00	0.00	0.0%
Professional/Consulting Services and Operating Expenditures		5800	1,518,815.00	10,089,237.00	11,608,052.00	2,215,699.00	8,630,329.00	10,846,028.00	-6.6%
Communications		5900	181,396.00	227,289.00	408,685.00	316,862.00	176,025.00	492,887.00	20.6%
TOTAL, SERVICES AND OTHER OPERATING EXPENDITURES			9,771,516.00	12,129,081.00	21,900,597.00	10,689,108.00	12,306,005.00	22,995,113.00	5.0%

Description	Resource Codes	Object Codes	2006-07 Estimated Actuals			2007-08 Budget			% Diff Column C & F
			Unrestricted (A)	Restricted (B)	Total Fund col. A + B (C)	Unrestricted (D)	Restricted (E)	Total Fund col. D + E (F)	
C. CAPITAL OUTLAY									
Land		6100	150,613.00	291,264.00	441,877.00	0.00	0.00	0.00	-100.0%
Improvements		6170	0.00	0.00	0.00	0.00	0.00	0.00	0.0%
Buildings and Improvements of Buildings		6200	55,834.00	695,740.00	751,574.00	15,000.00	100,000.00	115,000.00	-84.7%
Books and Media for New School Libraries or Major Expansion of School Libraries		6300	0.00	0.00	0.00	0.00	0.00	0.00	0.0%
Furniture		6400	43,801.00	127,937.00	171,738.00	10,000.00	66,000.00	76,000.00	-55.7%
Furniture Replacement		6500	25,566.00	59,499.00	85,065.00	0.00	59,000.00	59,000.00	-30.6%
TOTAL CAPITAL OUTLAY			275,814.00	1,174,440.00	1,450,254.00	25,000.00	225,000.00	250,000.00	-82.8%
D. OTHER OUTGO (excluding Transfers of Indirect/Direct Support Costs)									
Tuition									
Tuition for Instruction Under Interdistrict Attendance Agreements		7110	0.00	0.00	0.00	0.00	0.00	0.00	0.0%
State Special Schools		7130	0.00	6,595.00	6,595.00	0.00	7,000.00	7,000.00	6.1%
Tuition, Excess Costs, and/or Deficit Payments									
Payments to Districts or Charter Schools		7141	0.00	326,000.00	326,000.00	0.00	326,000.00	326,000.00	0.0%
Payments to County Offices		7142	0.00	1,472,000.00	1,472,000.00	0.00	1,430,000.00	1,430,000.00	-2.9%
Payments to JPAs		7143	0.00	0.00	0.00	0.00	0.00	0.00	0.0%
Transfers of Pass-Through Revenues									
To Districts or Charter Schools		7211	0.00	0.00	0.00	0.00	0.00	0.00	0.0%
To County Offices		7212	0.00	0.00	0.00	0.00	0.00	0.00	0.0%
To JPAs		7213	0.00	0.00	0.00	0.00	0.00	0.00	0.0%
Special Education SELPA Transfers of Apportionments									
To Districts or Charter Schools	6500	7221		0.00	0.00		0.00	0.00	0.0%
To County Offices	6500	7222		(631,842.00)	(631,842.00)		507,878.00	507,878.00	-180.4%
To JPAs	6500	7223		0.00	0.00		0.00	0.00	0.0%
KOC/IP Transfers of Apportionments									
To Districts or Charter Schools	6350, 6360	7221		0.00	0.00		0.00	0.00	0.0%
To County Offices	6350, 6360	7222		0.00	0.00		0.00	0.00	0.0%
To JPAs	6350, 6360	7223		0.00	0.00		0.00	0.00	0.0%
Other Transfers of Apportionments	All Other	7221-7223	0.00	0.00	0.00	0.00	0.00	0.00	0.0%
Transfers to Charter Schools in Lieu of Property Taxes		7280	8,171,892.00	0.00	8,171,892.00				
Other Transfers		7281-7283	0.00	0.00	0.00	0.00	0.00	0.00	0.0%
All Other Transfers Out to All Others		7299	0.00	0.00	0.00	0.00	0.00	0.00	0.0%
Debt Service									
Debt Service - Interest		7438	1,982.00	3,232.00	5,214.00	462.00	3,819.00	4,281.00	-17.8%
Other Debt Service - Principal		7439	41,535.00	514,839.00	556,374.00	46,526.00	468,440.00	514,966.00	-7.4%
TOTAL OTHER OUTGO (excluding Transfers of Indirect/Direct Support Costs)			8,215,409.00	1,690,824.00	9,906,233.00	46,988.00	2,743,137.00	2,790,125.00	-71.8%
TRANSFERS OF INDIRECT/DIRECT SUPPORT COSTS									
Transfers of Indirect Costs		7310	(2,990,191.00)	2,990,191.00	0.00	(1,815,145.00)	1,815,145.00	0.00	0.0%
Transfers of Indirect Costs - Interfund		7350	(426,613.00)	0.00	(426,613.00)	(146,040.00)	0.00	(146,040.00)	-65.8%
Transfers of Direct Support Costs		7370	0.00	0.00	0.00	0.00	0.00	0.00	0.0%
Transfers of Direct Support Costs - Interfund		7380	0.00	0.00	0.00	0.00	0.00	0.00	0.0%
TOTAL TRANSFERS OF INDIRECT/DIRECT SUPPORT COSTS			(3,416,804.00)	2,990,191.00	(426,613.00)	(1,961,185.00)	1,815,145.00	(146,040.00)	-65.8%
TOTAL EXPENDITURES			160,101,871.00	83,170,572.00	243,272,443.00	157,310,644.00	85,972,508.00	244,283,152.00	0.4%

Description	Resource Codes	Object Codes	2006-07 Estimated Actuals			2007-08 Budget			% Diff Column C & F
			Unrestricted (A)	Restricted (B)	Total Fund col. A + B (C)	Unrestricted (D)	Restricted (E)	Total Fund col. D + E (F)	
INTERFUND TRANSFERS									
INTERFUND TRANSFERS IN									
From: Special Reserve Fund		8912	29,676.00	0.00	29,676.00	0.00	0.00	0.00	-100.0%
From: Bond Interest and Redemption Fund		8914	0.00	0.00	0.00	0.00	0.00	0.00	0.0%
Other Authorized Interfund Transfers In		8919	0.00	0.00	0.00	0.00	0.00	0.00	0.0%
(b) TOTAL, INTERFUND TRANSFERS IN			29,676.00	0.00	29,676.00	0.00	0.00	0.00	-100.0%
INTERFUND TRANSFERS OUT									
To: Child Development Fund		7611	0.00	0.00	0.00	0.00	0.00	0.00	0.0%
To: Special Reserve Fund		7612	20,935.00	21,037.00	41,972.00	0.00	0.00	0.00	-100.0%
To: State School Building Fund/ County School Facilities Fund		7613	0.00	0.00	0.00	0.00	0.00	0.00	0.0%
To: Deferred Maintenance Fund		7615	0.00	1,146,791.00	1,146,791.00	0.00	1,215,600.00	1,215,600.00	6.0%
Cafeteria Fund		7616	0.00	0.00	0.00	0.00	0.00	0.00	0.0%
Other Authorized Interfund Transfers Out		7619	0.00	0.00	0.00	0.00	0.00	0.00	0.0%
(b) TOTAL, INTERFUND TRANSFERS OUT			20,935.00	1,167,828.00	1,188,763.00	0.00	1,215,600.00	1,215,600.00	2.3%
OTHER SOURCES/USES									
SOURCES									
State Apportionments Emergency Apportionments		8931	0.00	0.00	0.00	0.00	0.00	0.00	0.0%
Proceeds Proceeds from Sale/Lease- Purchase of Land/Buildings		8953	0.00	0.00	0.00	0.00	0.00	0.00	0.0%
Other Sources Transfers from Funds of Lapsed/Reorganized LEAs		8965	0.00	0.00	0.00	0.00	0.00	0.00	0.0%
Long-Term Debt Proceeds Proceeds from Certificates of Participation		8971	0.00	0.00	0.00	0.00	0.00	0.00	0.0%
Proceeds from Capital Leases		8972	0.00	0.00	0.00	0.00	0.00	0.00	0.0%
Proceeds from Lease Revenue Bonds		8973	0.00	0.00	0.00	0.00	0.00	0.00	0.0%
Other Financing Sources		8979	0.00	0.00	0.00	0.00	0.00	0.00	0.0%
(c) TOTAL, SOURCES			0.00	0.00	0.00	0.00	0.00	0.00	0.0%
USES									
Transfers from Funds of Lapsed/Reorganized LEAs		7651	0.00	0.00	0.00	0.00	0.00	0.00	0.0%
Other Financing Uses		7699	0.00	0.00	0.00	0.00	0.00	0.00	0.0%
(d) TOTAL, USES			0.00	0.00	0.00	0.00	0.00	0.00	0.0%
CONTRIBUTIONS									
Contributions from Unrestricted Revenues		8980	(18,149,782.00)	18,149,782.00	0.00	(20,451,741.00)	20,451,741.00	0.00	0.0%
Contributions from Restricted Revenues		8990	0.00	0.00	0.00	0.00	0.00	0.00	0.0%
Categorical Education Block Grant Transfers		8995	0.00	0.00	0.00	0.00	0.00	0.00	0.0%
Categorical Flexibility Transfers per Budget Act Section 12.40		8998	0.00	0.00	0.00	0.00	0.00	0.00	0.0%
(e) TOTAL, CONTRIBUTIONS			(18,149,782.00)	18,149,782.00	0.00	(20,451,741.00)	20,451,741.00	0.00	0.0%
TOTAL, OTHER FINANCING SOURCES/USES (b + c - d + e)			(18,141,041.00)	16,981,954.00	(1,159,087.00)	(20,451,741.00)	19,236,141.00	(1,215,600.00)	4.9%

IV

Other Funds

July 1 Budget (Single Adoption)
 Adult Education Fund
 Expenditures by Object

Orange Unified
 Orange County

30 66621 000000
 Form 11

Description	Resource Codes	Object Codes	2006-07 Estimated Actuals	2007-08 Budget	Percent Difference
A. REVENUES					
1) Revenue Limit Sources		8010-8099	14,038.00	0.00	-100.0%
2) Federal Revenue		8100-8299	0.00	0.00	0.0%
3) Other State Revenue		8300-8599	0.00	15,497.00	New
4) Other Local Revenue		8600-8799	1,000.00	300.00	-70.0%
5) TOTAL, REVENUES			15,038.00	15,797.00	5.0%
B. EXPENDITURES					
1) Certificated Salaries		1000-1999	5,733.00	5,977.00	4.3%
2) Classified Salaries		2000-2999	3,083.00	5,312.00	72.3%
3) Employee Benefits		3000-3999	2,603.00	1,047.00	-59.8%
4) Books and Supplies		4000-4999	1,756.00	3,064.00	74.5%
5) Services and Other Operating Expenditures		5000-5999	0.00	0.00	0.0%
6) Capital Outlay		6000-6999	0.00	0.00	0.0%
7) Other Outgo (excluding Transfers of Indirect/Direct Support Costs)		7100-7299, 7400-7499	0.00	0.00	0.0%
8) Transfers of Indirect/Direct Support Costs		7300-7399	1,863.00	397.00	-78.7%
9) TOTAL, EXPENDITURES			15,038.00	15,797.00	5.0%
C. EXCESS (DEFICIENCY) OF REVENUES OVER EXPENDITURES BEFORE OTHER FINANCING SOURCES AND USES (A5 - B9)			0.00	0.00	0.0%
D. OTHER FINANCING SOURCES/USES					
1) Interfund Transfers					
a) Transfers In		8910-8929	0.00	0.00	0.0%
b) Transfers Out		7610-7629	0.00	0.00	0.0%
2) Other Sources/Uses					
a) Sources		8930-8979	0.00	0.00	0.0%
b) Uses		7630-7699	0.00	0.00	0.0%
3) Contributions		8980-8999	0.00	0.00	0.0%
4) TOTAL, OTHER FINANCING SOURCES/USES			0.00	0.00	0.0%

July 1 Budget (Single Adoption)
 Adult Education Fund
 Expenditures by Object

Orange Unified
 Orange County

30 66621 000000
 Form 11

Description	Resource Codes	Object Codes	2006-07 Estimated Actuals	2007-08 Budget	Percent Difference
E. NET INCREASE (DECREASE) IN FUND BALANCE (C + D4)			0.00	0.00	0.0%
F. FUND BALANCE, RESERVES					
1) Beginning Fund Balance					
a) As of July 1 - Unaudited		9791	44,997.21	44,997.21	0.0%
b) Audit Adjustments		9793	0.00	0.00	0.0%
c) As of July 1 - Audited (F1a + F1b)			44,997.21	44,997.21	0.0%
d) Other Restatements		9795	0.00	0.00	0.0%
e) Adjusted Beginning Balance (F1c + F1d)			44,997.21	44,997.21	0.0%
2) Ending Balance, June 30 (E + F1e)			44,997.21	44,997.21	0.0%
Components of Ending Fund Balance					
a) Reserve for					
Revolving Cash		9711	0.00	0.00	0.0%
Stores		9712	0.00	0.00	0.0%
Prepaid Expenditures		9713	0.00	0.00	0.0%
All Others		9719	0.00	0.00	0.0%
General Reserve		9730	0.00	0.00	0.0%
Legally Restricted Balance		9740	0.00	0.00	0.0%
b) Designated Amounts					
Designated for Economic Uncertainties		9770	0.00	0.00	0.0%
Designated for the Unrealized Gains of Investments and Cash in County Treasury		9775	0.00	0.00	0.0%
Other Designations		9780	44,997.21	44,997.21	0.0%
Adult Education	6390	9780		44,997.21	
Adult Education	6390	9780	44,997.21		
c) Undesignated Amount			0.00		
d) Unappropriated Amount				0.00	

July 1 Budget (Single Adoption)
 Adult Education Fund
 Expenditures by Object

Orange Unified
 Orange County

30 66621 000000
 Form 11

Description	Resource Codes	Object Codes	2006-07 Estimated Actuals	2007-08 Budget	Percent Difference
REVENUE LIMIT SOURCES					
Principal Apportionment					
State Aid - Current Year		8011	12,653.00	0.00	-100.0%
State Aid - Prior Years		8019	1,385.00	0.00	-100.0%
Revenue Limit Transfers					
Unrestricted Revenue Limit Transfers - Current Year	0000	8091	0.00	0.00	0.0%
All Other Revenue Limit Transfers - Current Year	All Other	8091	0.00	0.00	0.0%
Revenue Limit Transfers - Prior Years		8099	0.00	0.00	0.0%
TOTAL, REVENUE LIMIT SOURCES			14,038.00	0.00	-100.0%
FEDERAL REVENUE					
Interagency Contracts Between LEAs		8285	0.00	0.00	0.0%
NCLB / IASA	3000-3299, 4000-4139, 4201-4215, 4610, 5510	8290	0.00	0.00	0.0%
Vocational and Applied Technology Education	3500-3699	8290	0.00	0.00	0.0%
Safe and Drug Free Schools	3700-3799	8290	0.00	0.00	0.0%
JTPA / WIA	5600-5625	8290	0.00	0.00	0.0%
Other Federal Revenue	All Other	8290	0.00	0.00	0.0%
TOTAL, FEDERAL REVENUE			0.00	0.00	0.0%
OTHER STATE REVENUE					
Other State Apportionments					
Adult Education					
Current Year	6390	8311		15,497.00	
Prior Years	6390	8319		0.00	
All Other State Revenue		8590	0.00	0.00	0.0%
TOTAL, OTHER STATE REVENUE			0.00	15,497.00	New

July 1 Budget (Single Adoption)
 Adult Education Fund
 Expenditures by Object

Orange Unified
 Orange County

30 66621 0000000
 Form 11

Description	Resource Codes	Object Codes	2006-07 Estimated Actuals	2007-08 Budget	Percent Difference
OTHER LOCAL REVENUE					
Other Local Revenue					
Sales					
Sale of Equipment/Supplies		8631	0.00	0.00	0.0%
Leases and Rentals		8650	0.00	0.00	0.0%
Interest		8660	1,000.00	300.00	-70.0%
Net Increase (Decrease) in the Fair Value of Investments		8662	0.00	0.00	0.0%
Fees and Contracts					
Adult Education Fees		8671	0.00	0.00	0.0%
Interagency Services		8677	0.00	0.00	0.0%
Other Local Revenue					
All Other Local Revenue		8699	0.00	0.00	0.0%
Tuition		8710	0.00	0.00	0.0%
TOTAL, OTHER LOCAL REVENUE			1,000.00	300.00	-70.0%
TOTAL, REVENUES			15,038.00	15,797.00	5.0%

July 1 Budget (Single Adoption)
 Adult Education Fund
 Expenditures by Object

Orange Unified
 Orange County

30 66621 000000
 Form 11

Description	Resource Codes	Object Codes	2006-07 Estimated Actuals	2007-08 Budget	Percent Difference
CERTIFICATED SALARIES					
Teachers' Salaries		1100	4,500.00	5,977.00	32.8%
Certificated Pupil Support Salaries		1200	0.00	0.00	0.0%
Certificated Supervisors' and Administrators' Salaries		1300	1,233.00	0.00	-100.0%
Other Certificated Salaries		1900	0.00	0.00	0.0%
TOTAL, CERTIFICATED SALARIES			5,733.00	5,977.00	4.3%
CLASSIFIED SALARIES					
Instructional Aides' Salaries		2100	0.00	0.00	0.0%
Classified Support Salaries		2200	0.00	0.00	0.0%
Classified Supervisors' and Administrators' Salaries		2300	0.00	0.00	0.0%
Clerical, Technical and Office Salaries		2400	3,083.00	5,312.00	72.3%
Other Classified Salaries		2900	0.00	0.00	0.0%
TOTAL, CLASSIFIED SALARIES			3,083.00	5,312.00	72.3%
EMPLOYEE BENEFITS					
STRS		3101-3102	504.00	493.00	-2.2%
PERS		3201-3202	0.00	0.00	0.0%
OASDI/Medicare/Alternative		3301-3302	730.00	233.00	-68.1%
Health and Welfare Benefits		3401-3402	678.00	0.00	-100.0%
Unemployment Insurance		3501-3502	12.00	6.00	-50.0%
Workers' Compensation		3601-3602	679.00	185.00	-72.8%
OPEB, Allocated		3701-3702	0.00	130.00	New
OPEB, Active Employees		3751-3752		0.00	
PERS Reduction		3801-3802	0.00	0.00	0.0%
Other Employee Benefits		3901-3902	0.00	0.00	0.0%
TOTAL, EMPLOYEE BENEFITS			2,603.00	1,047.00	-59.8%
BOOKS AND SUPPLIES					
Approved Textbooks and Core Curricula Materials		4100	0.00	0.00	0.0%
Books and Other Reference Materials		4200	500.00	0.00	-100.0%
Materials and Supplies		4300	1,256.00	3,064.00	143.9%
Noncapitalized Equipment		4400	0.00	0.00	0.0%
TOTAL, BOOKS AND SUPPLIES			1,756.00	3,064.00	74.5%

July 1 Budget (Single Adoption)
 Adult Education Fund
 Expenditures by Object

Orange Unified
 Orange County

30 66621 000000
 Form 11

Description	Resource Codes	Object Codes	2006-07 Estimated Actuals	2007-08 Budget	Percent Difference
SERVICES AND OTHER OPERATING EXPENDITURES					
Subagreements for Services		5100		0.00	
Travel and Conferences		5200	0.00	0.00	0.0%
Dues and Memberships		5300	0.00	0.00	0.0%
Insurance		5400-5450	0.00	0.00	0.0%
Operations and Housekeeping Services		5500	0.00	0.00	0.0%
Rentals, Leases, Repairs, and Noncapitalized Improvements		5600	0.00	0.00	0.0%
Transfers of Direct Costs		5710	0.00	0.00	0.0%
Transfers of Direct Costs - Interfund		5750	0.00	0.00	0.0%
Professional/Consulting Services and Operating Expenditures		5800	0.00	0.00	0.0%
Communications		5900	0.00	0.00	0.0%
TOTAL, SERVICES AND OTHER OPERATING EXPENDITURES			0.00	0.00	0.0%
CAPITAL OUTLAY					
Land		6100	0.00	0.00	0.0%
Land Improvements		6170	0.00	0.00	0.0%
Buildings and Improvements of Buildings		6200	0.00	0.00	0.0%
Equipment		6400	0.00	0.00	0.0%
Equipment Replacement		6500	0.00	0.00	0.0%
TOTAL, CAPITAL OUTLAY			0.00	0.00	0.0%
OTHER OUTGO (excluding Transfers of Indirect/Direct Support Costs)					
Tuition					
Tuition, Excess Costs, and/or Deficit Payments Payments to Districts or Charter Schools		7141	0.00	0.00	0.0%
Payments to County Offices		7142	0.00	0.00	0.0%
Payments to JPAs		7143	0.00	0.00	0.0%
Debt Service					
Debt Service - Interest		7438	0.00	0.00	0.0%
Other Debt Service - Principal		7439	0.00	0.00	0.0%
TOTAL, OTHER OUTGO (excluding Transfers of indirect/Direct Support Costs)			0.00	0.00	0.0%

July 1 Budget (Single Adoption)
 Adult Education Fund
 Expenditures by Object

Orange Unified
 Orange County

30 66621 000000
 Form 11

Description	Resource Codes	Object Codes	2006-07 Estimated Actuals	2007-08 Budget	Percent Difference
TRANSFERS OF INDIRECT/DIRECT SUPPORT COSTS					
Transfers of Indirect Costs - Interfund		7350	1,863.00	397.00	-78.7%
Transfers of Direct Support Costs		7370	0.00	0.00	0.0%
Transfers of Direct Support Costs - Interfund		7380	0.00	0.00	0.0%
TOTAL, TRANSFERS OF INDIRECT/DIRECT SUPPORT COSTS			1,863.00	397.00	-78.7%
TOTAL, EXPENDITURES			15,038.00	15,797.00	5.0%

July 1 Budget (Single Adoption)
 Adult Education Fund
 Expenditures by Object

Orange Unified
 Orange County

30 66621 000000
 Form 11

Description	Resource Codes	Object Codes	2006-07 Estimated Actuals	2007-08 Budget	Percent Difference
INTERFUND TRANSFERS					
INTERFUND TRANSFERS IN					
Other Authorized Interfund Transfers In		8919	0.00	0.00	0.0%
(a) TOTAL, INTERFUND TRANSFERS IN			0.00	0.00	0.0%
INTERFUND TRANSFERS OUT					
To: State School Building Fund/ County School Facilities Fund		7613	0.00	0.00	0.0%
Other Authorized Interfund Transfers Out		7619	0.00	0.00	0.0%
(b) TOTAL, INTERFUND TRANSFERS OUT			0.00	0.00	0.0%
OTHER SOURCES/USES					
SOURCES					
Other Sources					
Transfers from Funds of Lapsed/Reorganized LEAs		8965	0.00	0.00	0.0%
Long-Term Debt Proceeds					
Proceeds from Certificates of Participation		8971	0.00	0.00	0.0%
Proceeds from Capital Leases		8972	0.00	0.00	0.0%
All Other Financing Sources		8979	0.00	0.00	0.0%
(c) TOTAL, SOURCES			0.00	0.00	0.0%
USES					
Transfers from Funds of Lapsed/Reorganized LEAs		7651	0.00	0.00	0.0%
All Other Financing Uses		7699	0.00	0.00	0.0%
(d) TOTAL, USES			0.00	0.00	0.0%
CONTRIBUTIONS					
Contributions from Unrestricted Revenues		8980	0.00	0.00	0.0%
Contributions from Restricted Revenues		8990	0.00	0.00	0.0%
Categorical Education Block Grant Transfers		8995	0.00	0.00	0.0%
(e) TOTAL, CONTRIBUTIONS			0.00	0.00	0.0%
TOTAL, OTHER FINANCING SOURCES/USES (a - b + c - d + e)			0.00	0.00	0.0%

July 1 Budget (Single Adoption)
 Child Development Fund
 Expenditures by Object

Orange Unified
 Orange County

30 66621 000000
 Form 12

Description	Resource Codes	Object Codes	2006-07 Estimated Actuals	2007-08 Budget	Percent Difference
B. REVENUES					
1) Revenue Limit Sources		8010-8099	0.00	0.00	0.0%
2) Federal Revenue		8100-8299	3,105.00	0.00	-100.0%
3) Other State Revenue		8300-8599	1,007,619.00	1,007,619.00	0.0%
4) Other Local Revenue		8600-8799	4,153,995.00	4,363,000.00	5.0%
5) TOTAL, REVENUES			5,164,719.00	5,370,619.00	4.0%
C. EXPENDITURES					
1) Certificated Salaries		1000-1999	264,942.00	276,664.00	4.4%
2) Classified Salaries		2000-2999	3,009,180.00	3,290,253.00	9.3%
3) Employee Benefits		3000-3999	1,304,496.00	1,420,898.00	8.9%
4) Books and Supplies		4000-4999	293,733.00	169,700.00	-42.2%
5) Services and Other Operating Expenditures		5000-5999	314,338.00	175,300.00	-44.2%
6) Capital Outlay		6000-6999	0.00	0.00	0.0%
7) Other Outgo (excluding Transfers of Indirect/Direct Support Costs)		7100-7299, 7400-7499	13,337.00	12,362.00	-7.3%
8) Transfers of Indirect/Direct Support Costs		7300-7399	141,664.00	142,501.00	0.6%
9) TOTAL, EXPENDITURES			5,341,690.00	5,487,678.00	2.7%
C. EXCESS (DEFICIENCY) OF REVENUES OVER EXPENDITURES BEFORE OTHER FINANCING SOURCES AND USES (A5 - B9)			(176,971.00)	(117,059.00)	-33.9%
D. OTHER FINANCING SOURCES/USES					
1) Interfund Transfers					
a) Transfers In		8910-8929	0.00	0.00	0.0%
b) Transfers Out		7610-7629	0.00	0.00	0.0%
2) Other Sources/Uses					
a) Sources		8930-8979	0.00	0.00	0.0%
b) Uses		7630-7699	0.00	0.00	0.0%
3) Contributions		8980-8999	0.00	0.00	0.0%
4) TOTAL, OTHER FINANCING SOURCES/USES			0.00	0.00	0.0%

July 1 Budget (Single Adoption)
 Child Development Fund
 Expenditures by Object

Orange Unified
 Orange County

30 66621 000000
 Form 12

Description	Resource Codes	Object Codes	2006-07 Estimated Actuals	2007-08 Budget	Percent Difference
D. NET INCREASE (DECREASE) IN FUND					
BALANCE (C + D4)			(176,971.00)	(117,059.00)	-33.9%
E. FUND BALANCE, RESERVES					
1) Beginning Fund Balance					
a) As of July 1 - Unaudited		9791	308,301.92	131,330.92	-57.4%
b) Audit Adjustments		9793	0.00	0.00	0.0%
c) As of July 1 - Audited (F1a + F1b)			308,301.92	131,330.92	-57.4%
d) Other Restatements		9795	0.00	0.00	0.0%
e) Adjusted Beginning Balance (F1c + F1d)			308,301.92	131,330.92	-57.4%
2) Ending Balance, June 30 (E + F1e)					
Components of Ending Fund Balance					
a) Reserve for					
Revolving Cash		9711	0.00	0.00	0.0%
Stores		9712	0.00	0.00	0.0%
Prepaid Expenditures		9713	0.00	0.00	0.0%
All Others		9719	0.00	0.00	0.0%
General Reserve		9730	0.00	0.00	0.0%
Legally Restricted Balance		9740	0.00	0.00	0.0%
b) Designated Amounts					
Designated for Economic Uncertainties		9770	0.00	0.00	0.0%
Designated for the Unrealized Gains of Investments and Cash in County Treasury		9775	0.00	0.00	0.0%
Other Designations		9780	131,330.92	14,271.92	-89.1%
Child Development	9010	9780		14,271.92	
Child Development	9010	9780	131,330.92		
c) Undesignated Amount		9790	0.00		
d) Unappropriated Amount		9790		0.00	

July 1 Budget (Single Adoption)
 Child Development Fund
 Expenditures by Object

Orange Unified
 Orange County

30 66621 0000000
 Form 12

Description	Resource Codes	Object Codes	2006-07 Estimated Actuals	2007-08 Budget	Percent Difference
FEDERAL REVENUE					
Child Nutrition Programs		8220	0.00	0.00	0.0%
Interagency Contracts Between LEAs		8285	0.00	0.00	0.0%
Other Federal Revenue		8290	3,105.00	0.00	-100.0%
TOTAL, FEDERAL REVENUE			3,105.00	0.00	-100.0%
OTHER STATE REVENUE					
Child Nutrition Programs		8520	0.00	0.00	0.0%
Child Development Apportionments		8530	1,007,619.00	1,007,619.00	0.0%
Pass-Through Revenues from State Sources		8587	0.00	0.00	0.0%
State Preschool	6055-6056	8590	0.00	0.00	0.0%
All Other State Revenue	All Other	8590	0.00	0.00	0.0%
TOTAL, OTHER STATE REVENUE			1,007,619.00	1,007,619.00	0.0%
OTHER LOCAL REVENUE					
Other Local Revenue					
Sales					
Sale of Equipment/Supplies		8631	0.00	0.00	0.0%
Food Service Sales		8634	0.00	0.00	0.0%
Interest		8660	24,250.00	25,000.00	3.1%
Net Increase (Decrease) in the Fair Value of Investments		8662	0.00	0.00	0.0%
Fees and Contracts					
Child Development Parent Fees		8673	4,129,745.00	4,338,000.00	5.0%
Interagency Services		8677	0.00	0.00	0.0%
All Other Fees and Contracts		8689	0.00	0.00	0.0%
Other Local Revenue					
All Other Local Revenue		8699	0.00	0.00	0.0%
All Other Transfers In From All Others		8799	0.00	0.00	0.0%
TOTAL, OTHER LOCAL REVENUE			4,153,995.00	4,363,000.00	5.0%
TOTAL, REVENUES			5,164,719.00	5,370,619.00	4.0%

July 1 Budget (Single Adoption)
 Child Development Fund
 Expenditures by Object

Orange Unified
 Orange County

30 66621 000000
 Form 12

Description	Resource Codes	Object Codes	2006-07 Estimated Actuals	2007-08 Budget	Percent Difference
CERTIFICATED SALARIES					
Teachers' Salaries		1100	264,942.00	276,664.00	4.4%
Certificated Pupil Support Salaries		1200	0.00	0.00	0.0%
Certificated Supervisors' and Administrators' Salaries		1300	0.00	0.00	0.0%
Other Certificated Salaries		1900	0.00	0.00	0.0%
TOTAL, CERTIFICATED SALARIES			264,942.00	276,664.00	4.4%
CLASSIFIED SALARIES					
Instructional Aides' Salaries		2100	2,435,587.00	2,692,802.00	10.6%
Classified Support Salaries		2200	19,314.00	19,894.00	3.0%
Classified Supervisors' and Administrators' Salaries		2300	339,266.00	352,613.00	3.9%
Clerical, Technical and Office Salaries		2400	215,013.00	224,944.00	4.6%
Other Classified Salaries		2900	0.00	0.00	0.0%
TOTAL, CLASSIFIED SALARIES			3,009,180.00	3,290,253.00	9.3%
EMPLOYEE BENEFITS					
STRS		3101-3102	0.00	0.00	0.0%
PERS		3201-3202	415,422.00	440,822.00	6.1%
OASDI/Medicare/Alternative		3301-3302	232,894.00	245,326.00	5.3%
Health and Welfare Benefits		3401-3402	476,438.00	535,333.00	12.4%
Unemployment Insurance		3501-3502	1,692.00	1,797.00	6.2%
Workers' Compensation		3601-3602	55,490.00	58,865.00	6.1%
OPEB, Allocated		3701-3702	28,278.00	41,277.00	46.0%
OPEB, Active Employees		3751-3752		0.00	
PERS Reduction		3801-3802	94,282.00	97,478.00	3.4%
Other Employee Benefits		3901-3902	0.00	0.00	0.0%
TOTAL, EMPLOYEE BENEFITS			1,304,496.00	1,420,898.00	8.9%
BOOKS AND SUPPLIES					
Approved Textbooks and Core Curricula Materials		4100	0.00	0.00	0.0%
Books and Other Reference Materials		4200	0.00	0.00	0.0%
Materials and Supplies		4300	242,033.00	169,700.00	-29.9%
Noncapitalized Equipment		4400	51,700.00	0.00	-100.0%
Food		4700	0.00	0.00	0.0%
TOTAL, BOOKS AND SUPPLIES			293,733.00	169,700.00	-42.2%

July 1 Budget (Single Adoption)
 Child Development Fund
 Expenditures by Object

Orange Unified
 Orange County

30 66621 0000000
 Form 12

Description	Resource Codes	Object Codes	2006-07 Estimated Actuals	2007-08 Budget	Percent Difference
SERVICES AND OTHER OPERATING EXPENDITURES					
Subagreements for Services		5100		0.00	
Travel and Conferences		5200	21,450.00	18,300.00	-14.7%
Dues and Memberships		5300	0.00	0.00	0.0%
Insurance		5400-5450	0.00	0.00	0.0%
Operations and Housekeeping Services		5500	0.00	0.00	0.0%
Rentals, Leases, Repairs, and Noncapitalized Improvements		5600	38,191.00	26,500.00	-30.6%
Transfers of Direct Costs		5710	0.00	0.00	0.0%
Transfers of Direct Costs - Interfund		5750	0.00	0.00	0.0%
Professional/Consulting Services and Operating Expenditures		5800	246,497.00	119,700.00	-51.4%
Communications		5900	8,200.00	10,800.00	31.7%
TOTAL, SERVICES AND OTHER OPERATING EXPENDITURES			314,338.00	175,300.00	-44.2%
CAPITAL OUTLAY					
Land		6100	0.00	0.00	0.0%
Land Improvements		6170	0.00	0.00	0.0%
Buildings and Improvements of Buildings		6200	0.00	0.00	0.0%
Equipment		6400	0.00	0.00	0.0%
Equipment Replacement		6500	0.00	0.00	0.0%
TOTAL, CAPITAL OUTLAY			0.00	0.00	0.0%
OTHER OUTGO (excluding Transfers of Indirect/Direct Support Costs)					
Other Transfers Out					
All Other Transfers Out to All Others		7299	0.00	0.00	0.0%
Debt Service					
Debt Service - Interest		7438	0.00	0.00	0.0%
Other Debt Service - Principal		7439	13,337.00	12,362.00	-7.3%
TOTAL, OTHER OUTGO (excluding Transfers of indirect/Direct Support Costs)			13,337.00	12,362.00	-7.3%
TRANSFERS OF INDIRECT/DIRECT SUPPORT COSTS					
Transfers of Indirect Costs - Interfund		7350	141,664.00	142,501.00	0.6%
Transfers of Direct Support Costs		7370	0.00	0.00	0.0%
Transfers of Direct Support Costs - Interfund		7380	0.00	0.00	0.0%
TOTAL, TRANSFERS OF INDIRECT/DIRECT SUPPORT COSTS			141,664.00	142,501.00	0.6%
TOTAL, EXPENDITURES			5,341,690.00	5,487,678.00	2.7%

July 1 Budget (Single Adoption)
 Child Development Fund
 Expenditures by Object

Orange Unified
 Orange County

30 66621 000000
 Form 12

Description	Resource Codes	Object Codes	2006-07 Estimated Actuals	2007-08 Budget	Percent Difference
INTERFUND TRANSFERS					
INTERFUND TRANSFERS IN					
From: General Fund		8911	0.00	0.00	0.0%
Other Authorized Interfund Transfers In		8919	0.00	0.00	0.0%
(a) TOTAL, INTERFUND TRANSFERS IN			0.00	0.00	0.0%
INTERFUND TRANSFERS OUT					
Other Authorized Interfund Transfers Out		7619	0.00	0.00	0.0%
(b) TOTAL, INTERFUND TRANSFERS OUT			0.00	0.00	0.0%
OTHER SOURCES/USES					
SOURCES					
Other Sources					
Transfers from Funds of Lapsed/Reorganized LEAs		8965	0.00	0.00	0.0%
Long-Term Debt Proceeds					
Proceeds from Certificates of Participation		8971	0.00	0.00	0.0%
Proceeds from Capital Leases		8972	0.00	0.00	0.0%
All Other Financing Sources		8979	0.00	0.00	0.0%
(c) TOTAL, SOURCES			0.00	0.00	0.0%
USES					
Transfers from Funds of Lapsed/Reorganized LEAs		7651	0.00	0.00	0.0%
All Other Financing Uses		7699	0.00	0.00	0.0%
(d) TOTAL, USES			0.00	0.00	0.0%
CONTRIBUTIONS					
Contributions from Unrestricted Revenues		8980	0.00	0.00	0.0%
Contributions from Restricted Revenues		8990	0.00	0.00	0.0%
Categorical Education Block Grant Transfers		8995	0.00	0.00	0.0%
Categorical Flexibility Transfers per Budget Act Section 12.40		8998	0.00	0.00	0.0%
(e) TOTAL, CONTRIBUTIONS			0.00	0.00	0.0%
TOTAL, OTHER FINANCING SOURCES/USES (a - b + c - d + e)			0.00	0.00	0.0%

Description	Resource Codes	Object Codes	2006-07 Estimated Actuals	2007-08 Budget	Percent Difference
B. REVENUES					
1) Revenue Limit Sources		8010-8099	0.00	0.00	0.0%
2) Federal Revenue		8100-8299	4,058,295.00	4,227,044.00	4.2%
3) Other State Revenue		8300-8599	537,766.00	450,000.00	-16.3%
4) Other Local Revenue		8600-8799	3,187,781.00	3,188,000.00	0.0%
5) TOTAL, REVENUES			7,783,842.00	7,865,044.00	1.0%
C. EXPENDITURES					
1) Certificated Salaries		1000-1999	0.00	0.00	0.0%
2) Classified Salaries		2000-2999	2,739,507.00	2,861,008.00	4.4%
3) Employee Benefits		3000-3999	1,040,701.00	1,113,810.00	7.0%
4) Books and Supplies		4000-4999	3,388,965.00	3,416,858.00	0.8%
5) Services and Other Operating Expenditures		5000-5999	162,436.00	475,000.00	192.4%
6) Capital Outlay		6000-6999	124,780.00	0.00	-100.0%
7) Other Outgo (excluding Transfers of Indirect/Direct Support Costs)		7100-7299, 7400-7499	0.00	0.00	0.0%
8) Transfers of Indirect/Direct Support Costs		7300-7399	283,086.00	3,142.00	-98.9%
9) TOTAL, EXPENDITURES			7,739,475.00	7,869,818.00	1.7%
C. EXCESS (DEFICIENCY) OF REVENUES OVER EXPENDITURES BEFORE OTHER FINANCING SOURCES AND USES (A5 - B9)			44,367.00	(4,774.00)	-110.8%
D. OTHER FINANCING SOURCES/USES					
1) Interfund Transfers					
a) Transfers In		8910-8929	0.00	0.00	0.0%
b) Transfers Out		7610-7629	0.00	0.00	0.0%
2) Other Sources/Uses					
a) Sources		8930-8979	0.00	0.00	0.0%
b) Uses		7630-7699	0.00	0.00	0.0%
3) Contributions		8980-8999	0.00	0.00	0.0%
4) TOTAL, OTHER FINANCING SOURCES/USES			0.00	0.00	0.0%

Description	Resource Codes	Object Codes	2006-07 Estimated Actuals	2007-08 Budget	Percent Difference
E. NET INCREASE (DECREASE) IN FUND BALANCE (C + D4)			44,367.00	(4,774.00)	-110.8%
F. FUND BALANCE, RESERVES					
1) Beginning Fund Balance					
a) As of July 1 - Unaudited		9791	170,562.24	214,929.24	26.0%
b) Audit Adjustments		9793	0.00	0.00	0.0%
c) As of July 1 - Audited (F1a + F1b)			170,562.24	214,929.24	26.0%
d) Other Restatements		9795	0.00	0.00	0.0%
e) Adjusted Beginning Balance (F1c + F1d)			170,562.24	214,929.24	26.0%
2) Ending Balance, June 30 (E + F1e)					
Components of Ending Fund Balance					
a) Reserve for					
Revolving Cash		9711	10,000.00	10,000.00	0.0%
Stores		9712	110,965.49	110,000.00	-0.9%
Prepaid Expenditures		9713	0.00	0.00	0.0%
All Others		9719	0.00	0.00	0.0%
General Reserve		9730	0.00	0.00	0.0%
Legally Restricted Balance		9740	0.00	0.00	0.0%
b) Designated Amounts					
Designated for Economic Uncertainties		9770	0.00	0.00	0.0%
Designated for the Unrealized Gains of Investments and Cash in County Treasury		9775	0.00	0.00	0.0%
Other Designations		9780	93,963.75	90,155.24	-4.1%
Cafeteria	5310	9780		90,155.24	
Cafeteria	5310	9780	93,963.75		
c) Undesignated Amount					
d) Unappropriated Amount					
		9790		0.00	

Description	Resource Codes	Object Codes	2006-07 Estimated Actuals	2007-08 Budget	Percent Difference
REVENUE LIMIT SOURCES					
Revenue Limit Transfers					
Unrestricted Revenue Limit Transfers - Current Year	0000	8091	0.00	0.00	0.0%
All Other Revenue Limit Transfers - Current Year	All Other	8091	0.00	0.00	0.0%
Revenue Limit Transfers - Prior Years		8099	0.00	0.00	0.0%
TOTAL, REVENUE LIMIT SOURCES			0.00	0.00	0.0%
FEDERAL REVENUE					
Child Nutrition Programs		8220	4,058,295.00	4,227,044.00	4.2%
Other Federal Revenue		8290	0.00	0.00	0.0%
TOTAL, FEDERAL REVENUE			4,058,295.00	4,227,044.00	4.2%
OTHER STATE REVENUE					
Child Nutrition Programs		8520	537,766.00	450,000.00	-16.3%
All Other State Revenue		8590	0.00	0.00	0.0%
TOTAL, OTHER STATE REVENUE			537,766.00	450,000.00	-16.3%
OTHER LOCAL REVENUE					
Other Local Revenue					
Sales					
Sale of Equipment/Supplies		8631	0.00	0.00	0.0%
Food Service Sales		8634	3,119,538.00	3,122,000.00	0.1%
Leases and Rentals		8650	0.00	0.00	0.0%
Interest		8660	21,100.00	20,000.00	-5.2%
Net Increase (Decrease) in the Fair Value of Investments		8662	0.00	0.00	0.0%
Fees and Contracts					
Interagency Services		8677	0.00	0.00	0.0%
Other Local Revenue					
All Other Local Revenue		8699	47,143.00	46,000.00	-2.4%
TOTAL, OTHER LOCAL REVENUE			3,187,781.00	3,188,000.00	0.0%
TOTAL, REVENUES			7,783,842.00	7,865,044.00	1.0%

July 1 Budget (Single Adoption)
 Cafeteria Special Revenue Fund
 Expenditures by Object

Orange Unified
 Orange County

30 66621 000000
 Form 13

Description	Resource Codes	Object Codes	2006-07 Estimated Actuals	2007-08 Budget	Percent Difference
CERTIFICATED SALARIES					
Certificated Supervisors' and Administrators' Salaries		1300	0.00	0.00	0.0%
Other Certificated Salaries		1900	0.00	0.00	0.0%
TOTAL, CERTIFICATED SALARIES			0.00	0.00	0.0%
CLASSIFIED SALARIES					
Classified Support Salaries		2200	1,745,657.00	1,814,975.00	4.0%
Classified Supervisors' and Administrators' Salaries		2300	724,827.00	767,602.00	5.9%
Clerical, Technical and Office Salaries		2400	267,311.00	276,631.00	3.5%
Other Classified Salaries		2900	1,712.00	1,800.00	5.1%
TOTAL, CLASSIFIED SALARIES			2,739,507.00	2,861,008.00	4.4%
EMPLOYEE BENEFITS					
STRS		3101-3102	0.00	0.00	0.0%
PERS		3201-3202	299,160.00	312,035.00	4.3%
OASDI/Medicare/Alternative		3301-3302	183,811.00	201,916.00	9.8%
Health and Welfare Benefits		3401-3402	480,725.00	514,431.00	7.0%
Unemployment Insurance		3501-3502	1,341.00	1,419.00	5.8%
Workers' Compensation		3601-3602	61,200.00	49,382.00	-19.3%
OPEB, Allocated		3701-3702	14,464.00	34,627.00	139.4%
OPEB, Active Employees		3751-3752		0.00	
PERS Reduction		3801-3802	0.00	0.00	0.0%
Other Employee Benefits		3901-3902	0.00	0.00	0.0%
TOTAL, EMPLOYEE BENEFITS			1,040,701.00	1,113,810.00	7.0%
BOOKS AND SUPPLIES					
Books and Other Reference Materials		4200	0.00	0.00	0.0%
Materials and Supplies		4300	66,356.00	71,000.00	7.0%
Noncapitalized Equipment		4400	45,660.00	9,000.00	-80.3%
Food		4700	3,276,949.00	3,336,858.00	1.8%
TOTAL, BOOKS AND SUPPLIES			3,388,965.00	3,416,858.00	0.8%

Description	Resource Codes	Object Codes	2006-07 Estimated Actuals	2007-08 Budget	Percent Difference
SERVICES AND OTHER OPERATING EXPENDITURES					
Subagreements for Services		5100		0.00	
Travel and Conferences		5200	11,971.00	12,200.00	1.9%
Dues and Memberships		5300	0.00	0.00	0.0%
Insurance		5400-5450	0.00	0.00	0.0%
Operations and Housekeeping Services		5500	0.00	0.00	0.0%
Rentals, Leases, Repairs, and Noncapitalized Improvements		5600	69,342.00	380,300.00	448.4%
Transfers of Direct Costs		5710	0.00	0.00	0.0%
Transfers of Direct Costs - Interfund		5750	0.00	0.00	0.0%
Professional/Consulting Services and Operating Expenditures		5800	71,957.00	73,000.00	1.4%
Communications		5900	9,166.00	9,500.00	3.6%
TOTAL, SERVICES AND OTHER OPERATING EXPENDITURES			162,436.00	475,000.00	192.4%
CAPITAL OUTLAY					
Buildings and Improvements of Buildings		6200	0.00	0.00	0.0%
Equipment		6400	0.00	0.00	0.0%
Equipment Replacement		6500	124,780.00	0.00	-100.0%
TOTAL, CAPITAL OUTLAY			124,780.00	0.00	-100.0%
OTHER OUTGO (excluding Transfers of Indirect/Direct Support Costs)					
Debt Service					
Debt Service - Interest		7438	0.00	0.00	0.0%
Other Debt Service - Principal		7439	0.00	0.00	0.0%
TOTAL, OTHER OUTGO (excluding Transfers of indirect/Direct Support Costs)			0.00	0.00	0.0%
TRANSFERS OF INDIRECT/DIRECT SUPPORT COSTS					
Transfers of Indirect Costs - Interfund		7350	283,086.00	3,142.00	-98.9%
Transfers of Direct Support Costs		7370	0.00	0.00	0.0%
Transfers of Direct Support Costs - Interfund		7380	0.00	0.00	0.0%
TOTAL, TRANSFERS OF INDIRECT/DIRECT SUPPORT COSTS			283,086.00	3,142.00	-98.9%
TOTAL, EXPENDITURES			7,739,475.00	7,869,818.00	1.7%

July 1 Budget (Single Adoption)
 Cafeteria Special Revenue Fund
 Expenditures by Object

Orange Unified
 Orange County

30 66621 000000
 Form 13

Description	Resource Codes	Object Codes	2006-07 Estimated Actuals	2007-08 Budget	Percent Difference
INTERFUND TRANSFERS					
INTERFUND TRANSFERS IN					
From: General Fund		8916	0.00	0.00	0.0%
Other Authorized Interfund Transfers In		8919	0.00	0.00	0.0%
(a) TOTAL, INTERFUND TRANSFERS IN			0.00	0.00	0.0%
INTERFUND TRANSFERS OUT					
Other Authorized Interfund Transfers Out		7619	0.00	0.00	0.0%
(b) TOTAL, INTERFUND TRANSFERS OUT			0.00	0.00	0.0%
OTHER SOURCES/USES					
SOURCES					
Other Sources					
Transfers from Funds of Lapsed/Reorganized LEAs		8965	0.00	0.00	0.0%
Long-Term Debt Proceeds					
Proceeds from Capital Leases		8972	0.00	0.00	0.0%
All Other Financing Sources		8979	0.00	0.00	0.0%
(c) TOTAL, SOURCES			0.00	0.00	0.0%
USES					
Transfers from Funds of Lapsed/Reorganized LEAs		7651	0.00	0.00	0.0%
All Other Financing Uses		7699	0.00	0.00	0.0%
(d) TOTAL, USES			0.00	0.00	0.0%
CONTRIBUTIONS					
Contributions from Unrestricted Revenues		8980	0.00	0.00	0.0%
Contributions from Restricted Revenues		8990	0.00	0.00	0.0%
Categorical Education Block Grant Transfers		8995	0.00	0.00	0.0%
Categorical Flexibility Transfers per Budget Act Section 12.40		8998	0.00	0.00	0.0%
(e) TOTAL, CONTRIBUTIONS			0.00	0.00	0.0%
TOTAL, OTHER FINANCING SOURCES/USES (a - b + c - d + e)			0.00	0.00	0.0%

July 1 Budget (Single Adoption)
Deferred Maintenance Fund
Expenditures by Object

Orange Unified
Orange County

30 66621 000000
Form 14

Description	Resource Codes	Object Codes	2006-07 Estimated Actuals	2007-08 Budget	Percent Difference
B. REVENUES					
1) Revenue Limit Sources		8010-8099	0.00	0.00	0.0%
2) Federal Revenue		8100-8299	0.00	0.00	0.0%
3) Other State Revenue		8300-8599	1,122,479.00	1,256,000.00	11.9%
4) Other Local Revenue		8600-8799	146,443.00	125,000.00	-14.6%
5) TOTAL, REVENUES			1,268,922.00	1,381,000.00	8.8%
C. EXPENDITURES					
1) Certificated Salaries		1000-1999	0.00	0.00	0.0%
2) Classified Salaries		2000-2999	0.00	0.00	0.0%
3) Employee Benefits		3000-3999	0.00	0.00	0.0%
4) Books and Supplies		4000-4999	336,401.00	450,000.00	33.8%
5) Services and Other Operating Expenditures		5000-5999	616,631.00	275,000.00	-55.4%
6) Capital Outlay		6000-6999	1,865,130.00	1,775,000.00	-4.8%
7) Other Outgo (excluding Transfers of Indirect/Direct Support Costs)		7100-7299, 7400-7499	0.00	0.00	0.0%
8) Transfers of Indirect/Direct Support Costs		7300-7399	0.00	0.00	0.0%
9) TOTAL, EXPENDITURES			2,818,162.00	2,500,000.00	-11.3%
C. EXCESS (DEFICIENCY) OF REVENUES OVER EXPENDITURES BEFORE OTHER FINANCING SOURCES AND USES (A5 - B9)			(1,549,240.00)	(1,119,000.00)	-27.8%
D. OTHER FINANCING SOURCES/USES					
1) Interfund Transfers					
a) Transfers In		8910-8929	1,911,952.00	1,215,600.00	-36.4%
b) Transfers Out		7610-7629	0.00	0.00	0.0%
2) Other Sources/Uses					
a) Sources		8930-8979	0.00	0.00	0.0%
b) Uses		7630-7699	0.00	0.00	0.0%
3) Contributions		8980-8999	0.00	0.00	0.0%
4) TOTAL, OTHER FINANCING SOURCES/USES			1,911,952.00	1,215,600.00	-36.4%

July 1 Budget (Single Adoption)
 Deferred Maintenance Fund
 Expenditures by Object

Orange Unified
 Orange County

30 66621 000000
 Form 14

Description	Resource Codes	Object Codes	2006-07 Estimated Actuals	2007-08 Budget	Percent Difference
E. NET INCREASE (DECREASE) IN FUND BALANCE (C + D4)			362,712.00	96,600.00	-73.4%
F. FUND BALANCE, RESERVES					
1) Beginning Fund Balance					
a) As of July 1 - Unaudited		9791	3,585,260.84	3,947,972.84	10.1%
b) Audit Adjustments		9793	0.00	0.00	0.0%
c) As of July 1 - Audited (F1a + F1b)			3,585,260.84	3,947,972.84	10.1%
d) Other Restatements		9795	0.00	0.00	0.0%
e) Adjusted Beginning Balance (F1c + F1d)			3,585,260.84	3,947,972.84	10.1%
2) Ending Balance, June 30 (E + F1e)					
Components of Ending Fund Balance					
a) Reserve for					
Revolving Cash		9711	0.00	0.00	0.0%
Stores		9712	0.00	0.00	0.0%
Prepaid Expenditures		9713	0.00	0.00	0.0%
All Others		9719	0.00	0.00	0.0%
General Reserve		9730	0.00	0.00	0.0%
Legally Restricted Balance		9740	0.00	0.00	0.0%
b) Designated Amounts					
Designated for Economic Uncertainties		9770	0.00	0.00	0.0%
Designated for the Unrealized Gains of Investments and Cash in County Treasury		9775	0.00	0.00	0.0%
Other Designations		9780	3,947,972.84	4,044,572.84	2.4%
Deferred Maintenance	6205	9780		4,044,572.84	
Deferred Maintenance	6205	9780	3,947,972.84		
c) Undesignated Amount					
		9790	0.00		
d) Unappropriated Amount					
		9790		0.00	

Description	Resource Codes	Object Codes	2006-07 Estimated Actuals	2007-08 Budget	Percent Difference
OTHER STATE REVENUE					
Deferred Maintenance Allowance		8540	1,122,479.00	1,256,000.00	11.9%
All Other State Revenue		8590	0.00	0.00	0.0%
TOTAL, OTHER STATE REVENUE			1,122,479.00	1,256,000.00	11.9%
OTHER LOCAL REVENUE					
Other Local Revenue					
Sales					
Sale of Equipment/Supplies		8631	0.00	0.00	0.0%
Interest		8660	146,443.00	125,000.00	-14.6%
Net Increase (Decrease) in the Fair Value of Investments		8662	0.00	0.00	0.0%
Other Local Revenue					
All Other Local Revenue					
All Other Transfers In From All Others		8799	0.00	0.00	0.0%
TOTAL, OTHER LOCAL REVENUE			146,443.00	125,000.00	-14.6%
TOTAL, REVENUES			1,268,922.00	1,381,000.00	8.8%

July 1 Budget (Single Adoption)
 Deferred Maintenance Fund
 Expenditures by Object

Orange Unified
 Orange County

30 66621 000000
 Form 14

Description	Resource Codes	Object Codes	2006-07 Estimated Actuals	2007-08 Budget	Percent Difference
CLASSIFIED SALARIES					
Classified Support Salaries		2200	0.00	0.00	0.0%
Other Classified Salaries		2900	0.00	0.00	0.0%
TOTAL, CLASSIFIED SALARIES			0.00	0.00	0.0%
EMPLOYEE BENEFITS					
STRS		3101-3102	0.00	0.00	0.0%
PERS		3201-3202	0.00	0.00	0.0%
OASDI/Medicare/Alternative		3301-3302	0.00	0.00	0.0%
Health and Welfare Benefits		3401-3402	0.00	0.00	0.0%
Unemployment Insurance		3501-3502	0.00	0.00	0.0%
Workers' Compensation		3601-3602	0.00	0.00	0.0%
OPEB, Allocated		3701-3702	0.00	0.00	0.0%
OPEB, Active Employees		3751-3752		0.00	
PERS Reduction		3801-3802	0.00	0.00	0.0%
Other Employee Benefits		3901-3902	0.00	0.00	0.0%
TOTAL, EMPLOYEE BENEFITS			0.00	0.00	0.0%
BOOKS AND SUPPLIES					
Books and Other Reference Materials		4200	0.00	0.00	0.0%
Materials and Supplies		4300	336,401.00	450,000.00	33.8%
Noncapitalized Equipment		4400	0.00	0.00	0.0%
TOTAL, BOOKS AND SUPPLIES			336,401.00	450,000.00	33.8%

July 1 Budget (Single Adoption)
 Deferred Maintenance Fund
 Expenditures by Object

Orange Unified
 Orange County

30 66621 000000
 Form 14

Description	Resource Codes	Object Codes	2006-07 Estimated Actuals	2007-08 Budget	Percent Difference
SERVICES AND OTHER OPERATING EXPENDITURES					
Subagreements for Services		5100		0.00	
Travel and Conferences		5200	0.00	0.00	0.0%
Rentals, Leases, Repairs, and Noncapitalized Improvements		5600	499,256.00	150,000.00	-70.0%
Transfers of Direct Costs		5710	0.00	0.00	0.0%
Transfers of Direct Costs - Interfund		5750	0.00	0.00	0.0%
Professional/Consulting Services and Operating Expenditures		5800	117,375.00	125,000.00	6.5%
TOTAL, SERVICES AND OTHER OPERATING EXPENDITURES			616,631.00	275,000.00	-55.4%
CAPITAL OUTLAY					
Land Improvements		6170	0.00	0.00	0.0%
Buildings and Improvements of Buildings		6200	1,537,989.00	1,475,000.00	-4.1%
Equipment		6400	0.00	0.00	0.0%
Equipment Replacement		6500	327,141.00	300,000.00	-8.3%
TOTAL, CAPITAL OUTLAY			1,865,130.00	1,775,000.00	-4.8%
OTHER OUTGO (excluding Transfers of Indirect/Direct Support Costs)					
Debt Service					
Debt Service - Interest		7438	0.00	0.00	0.0%
Other Debt Service - Principal		7439	0.00	0.00	0.0%
TOTAL, OTHER OUTGO (excluding Transfers of indirect/Direct Support Costs)			0.00	0.00	0.0%
TRANSFERS OF INDIRECT/DIRECT SUPPORT COSTS					
Transfers of Direct Support Costs		7370	0.00	0.00	0.0%
TOTAL, TRANSFERS OF INDIRECT/DIRECT SUPPORT COSTS			0.00	0.00	0.0%
TOTAL, EXPENDITURES			2,818,162.00	2,500,000.00	-11.3%

July 1 Budget (Single Adoption)
Deferred Maintenance Fund
Expenditures by Object

Orange Unified
Orange County

30 66621 000000
Form 14

Description	Resource Codes	Object Codes	2006-07 Estimated Actuals	2007-08 Budget	Percent Difference
INTERFUND TRANSFERS					
INTERFUND TRANSFERS IN					
From: General, Special Reserve, & Building Funds		8915	1,911,952.00	1,215,600.00	-36.4%
Other Authorized Interfund Transfers In		8919	0.00	0.00	0.0%
(a) TOTAL, INTERFUND TRANSFERS IN			1,911,952.00	1,215,600.00	-36.4%
INTERFUND TRANSFERS OUT					
Other Authorized Interfund Transfers Out		7619	0.00	0.00	0.0%
(b) TOTAL, INTERFUND TRANSFERS OUT			0.00	0.00	0.0%
OTHER SOURCES/USES					
SOURCES					
Other Sources					
Transfers from Funds of Lapsed/Reorganized LEAs		8965	0.00	0.00	0.0%
Long-Term Debt Proceeds					
Proceeds from Capital Leases		8972	0.00	0.00	0.0%
All Other Financing Sources		8979	0.00	0.00	0.0%
(c) TOTAL, SOURCES			0.00	0.00	0.0%
USES					
Transfers from Funds of Lapsed/Reorganized LEAs		7651	0.00	0.00	0.0%
All Other Financing Uses		7699	0.00	0.00	0.0%
(d) TOTAL, USES			0.00	0.00	0.0%
CONTRIBUTIONS					
Contributions from Unrestricted Revenues		8980	0.00	0.00	0.0%
Contributions from Restricted Revenues		8990	0.00	0.00	0.0%
Categorical Education Block Grant Transfers		8995	0.00	0.00	0.0%
(e) TOTAL, CONTRIBUTIONS			0.00	0.00	0.0%
TOTAL, OTHER FINANCING SOURCES/USES (a - b + c - d + e)			1,911,952.00	1,215,600.00	-36.4%

July 1 Budget (Single Adoption)
 Capital Facilities Fund
 Expenditures by Object

Orange Unified
 Orange County

30 66621 000000
 Form 25

Description	Resource Codes	Object Codes	2006-07 Estimated Actuals	2007-08 Budget	Percent Difference
A. REVENUES					
1) Revenue Limit Sources		8010-8099	0.00	0.00	0.0%
2) Federal Revenue		8100-8299	0.00	0.00	0.0%
3) Other State Revenue		8300-8599	0.00	0.00	0.0%
4) Other Local Revenue		8600-8799	1,928,349.00	1,480,000.00	-23.3%
5) TOTAL, REVENUES			1,928,349.00	1,480,000.00	-23.3%
B. EXPENDITURES					
1) Certificated Salaries		1000-1999	0.00	0.00	0.0%
2) Classified Salaries		2000-2999	468,094.00	541,156.00	15.6%
3) Employee Benefits		3000-3999	147,093.00	184,086.00	25.1%
4) Books and Supplies		4000-4999	55,087.00	25,500.00	-53.7%
5) Services and Other Operating Expenditures		5000-5999	179,833.00	159,545.00	-11.3%
6) Capital Outlay		6000-6999	727,828.00	1,000,000.00	37.4%
7) Other Outgo (excluding Transfers of Indirect/Direct Support Costs)		7100-7299, 7400-7499	258,320.00	258,320.00	0.0%
8) Transfers of Indirect/Direct Support Costs		7300-7399	0.00	0.00	0.0%
9) TOTAL, EXPENDITURES			1,836,255.00	2,168,607.00	18.1%
C. EXCESS (DEFICIENCY) OF REVENUES OVER EXPENDITURES BEFORE OTHER FINANCING SOURCES AND USES (A5 - B9)			92,094.00	(688,607.00)	-847.7%
D. OTHER FINANCING SOURCES/USES					
1) Interfund Transfers					
a) Transfers In		8910-8929	0.00	0.00	0.0%
b) Transfers Out		7610-7629	0.00	0.00	0.0%
2) Other Sources/Uses					
a) Sources		8930-8979	0.00	0.00	0.0%
b) Uses		7630-7699	0.00	0.00	0.0%
3) Contributions		8980-8999	0.00	0.00	0.0%
4) TOTAL, OTHER FINANCING SOURCES/USES			0.00	0.00	0.0%

July 1 Budget (Single Adoption)
 Capital Facilities Fund
 Expenditures by Object

Orange Unified
 Orange County

30 66621 000000
 Form 25

Description	Resource Codes	Object Codes	2006-07 Estimated Actuals	2007-08 Budget	Percent Difference
E. NET INCREASE (DECREASE) IN FUND BALANCE (C + D4)			92,094.00	(688,607.00)	-847.7%
IF. FUND BALANCE, RESERVES					
1) Beginning Fund Balance					
a) As of July 1 - Unaudited		9791	4,562,744.32	4,654,838.32	2.0%
b) Audit Adjustments		9793	0.00	0.00	0.0%
c) As of July 1 - Audited (F1a + F1b)			4,562,744.32	4,654,838.32	2.0%
d) Other Restatements		9795	0.00	0.00	0.0%
e) Adjusted Beginning Balance (F1c + F1d)			4,562,744.32	4,654,838.32	2.0%
2) Ending Balance, June 30 (E + F1e)					
Components of Ending Fund Balance					
a) Reserve for					
Revolving Cash		9711	0.00	0.00	0.0%
Stores		9712	0.00	0.00	0.0%
Prepaid Expenditures		9713	0.00	0.00	0.0%
All Others		9719	0.00	0.00	0.0%
General Reserve		9730	0.00	0.00	0.0%
Legally Restricted Balance		9740	0.00	0.00	0.0%
b) Designated Amounts					
Designated for Economic Uncertainties		9770	0.00	0.00	0.0%
Designated for the Unrealized Gains of Investments and Cash in County Treasury		9775	0.00	0.00	0.0%
Other Designations		9780	4,654,838.32	3,966,231.32	-14.8%
Capital Facilities	0000	9780		3,966,231.32	
Capital Facilities	0000	9780	4,654,838.32		
c) Undesignated Amount					
		9790	0.00		
d) Unappropriated Amount					
		9790		0.00	

July 1 Budget (Single Adoption)
 Capital Facilities Fund
 Expenditures by Object

Orange Unified
 Orange County

30 66621 0000000
 Form 25

Description	Resource Codes	Object Codes	2006-07 Estimated Actuals	2007-08 Budget	Percent Difference
OTHER STATE REVENUE					
Tax Relief Subventions Restricted Levies - Other					
Homeowners' Exemptions		8575	0.00	0.00	0.0%
Other Subventions/In-Lieu Taxes		8576	0.00	0.00	0.0%
All Other State Revenue		8590	0.00	0.00	0.0%
TOTAL, OTHER STATE REVENUE			0.00	0.00	0.0%
OTHER LOCAL REVENUE					
Other Local Revenue County and District Taxes					
Other Restricted Levies Secured Roll		8615	0.00	0.00	0.0%
Unsecured Roll		8616	0.00	0.00	0.0%
Prior Years' Taxes		8617	0.00	0.00	0.0%
Supplemental Taxes		8618	0.00	0.00	0.0%
Non-Ad Valorem Taxes Parcel Taxes		8621	0.00	0.00	0.0%
Other		8622	0.00	0.00	0.0%
Community Redevelopment Funds Not Subject to RL Deduction		8625	0.00	0.00	0.0%
Penalties and Interest from Delinquent Non-Revenue Limit Taxes		8629	0.00	0.00	0.0%
Sales Sale of Equipment/Supplies		8631	0.00	0.00	0.0%
Interest		8660	243,625.00	180,000.00	-26.1%
Net Increase (Decrease) in the Fair Value of Investments		8662	0.00	0.00	0.0%
Fees and Contracts					
Mitigation/Developer Fees		8681	1,684,724.00	1,300,000.00	-22.8%
Other Local Revenue					
All Other Local Revenue		8699	0.00	0.00	0.0%
All Other Transfers In From All Others		8799	0.00	0.00	0.0%
TOTAL, OTHER LOCAL REVENUE			1,928,349.00	1,480,000.00	-23.3%
TOTAL, REVENUES			1,928,349.00	1,480,000.00	-23.3%

July 1 Budget (Single Adoption)
 Capital Facilities Fund
 Expenditures by Object

Orange Unified
 Orange County

30 66621 000000
 Form 25

Description	Resource Codes	Object Codes	2006-07 Estimated Actuals	2007-08 Budget	Percent Difference
CERTIFICATED SALARIES					
Other Certificated Salaries		1900	0.00	0.00	0.0%
TOTAL, CERTIFICATED SALARIES			0.00	0.00	0.0%
CLASSIFIED SALARIES					
Classified Support Salaries		2200	607.00	0.00	-100.0%
Classified Supervisors' and Administrators' Salaries		2300	353,343.00	415,591.00	17.6%
Clerical, Technical and Office Salaries		2400	114,144.00	125,565.00	10.0%
Other Classified Salaries		2900	0.00	0.00	0.0%
TOTAL, CLASSIFIED SALARIES			468,094.00	541,156.00	15.6%
EMPLOYEE BENEFITS					
STRS		3101-3102	0.00	0.00	0.0%
PERS		3201-3202	33,385.00	52,011.00	55.8%
OASDI/Medicare/Alternative		3301-3302	33,358.00	39,114.00	17.3%
Health and Welfare Benefits		3401-3402	49,123.00	56,820.00	15.7%
Unemployment Insurance		3501-3502	217.00	270.00	24.4%
Workers' Compensation		3601-3602	10,688.00	8,876.00	-17.0%
OPEB, Allocated		3701-3702	2,095.00	6,223.00	197.0%
OPEB, Active Employees		3751-3752		0.00	
PERS Reduction		3801-3802	18,227.00	20,772.00	14.0%
Other Employee Benefits		3901-3902	0.00	0.00	0.0%
TOTAL, EMPLOYEE BENEFITS			147,093.00	184,086.00	25.1%
BOOKS AND SUPPLIES					
Approved Textbooks and Core Curricula Materials		4100	0.00	0.00	0.0%
Books and Other Reference Materials		4200	0.00	0.00	0.0%
Materials and Supplies		4300	53,403.00	21,500.00	-59.7%
Noncapitalized Equipment		4400	1,684.00	4,000.00	137.5%
TOTAL, BOOKS AND SUPPLIES			55,087.00	25,500.00	-53.7%

July 1 Budget (Single Adoption)
 Capital Facilities Fund
 Expenditures by Object

Orange Unified
 Orange County

30 66621 000000
 Form 25

Description	Resource Codes	Object Codes	2006-07 Estimated Actuals	2007-08 Budget	Percent Difference
SERVICES AND OTHER OPERATING EXPENDITURES					
Subagreements for Services		5100		0.00	
Travel and Conferences		5200	12,260.00	16,000.00	30.5%
Insurance		5400-5450	0.00	0.00	0.0%
Operations and Housekeeping Services		5500	0.00	0.00	0.0%
Rentals, Leases, Repairs, and Noncapitalized Improvements		5600	27,210.00	23,745.00	-12.7%
Transfers of Direct Costs		5710	0.00	0.00	0.0%
Transfers of Direct Costs - Interfund		5750	0.00	0.00	0.0%
Professional/Consulting Services and Operating Expenditures		5800	137,215.00	115,500.00	-15.8%
Communications		5900	3,148.00	4,300.00	36.6%
TOTAL, SERVICES AND OTHER OPERATING EXPENDITURES			179,833.00	159,545.00	-11.3%
CAPITAL OUTLAY					
Land		6100	0.00	0.00	0.0%
Land Improvements		6170	0.00	0.00	0.0%
Buildings and Improvements of Buildings		6200	727,828.00	1,000,000.00	37.4%
Books and Media for New School Libraries or Major Expansion of School Libraries		6300	0.00	0.00	0.0%
Equipment		6400	0.00	0.00	0.0%
Equipment Replacement		6500	0.00	0.00	0.0%
TOTAL, CAPITAL OUTLAY			727,828.00	1,000,000.00	37.4%
OTHER OUTGO (excluding Transfers of Indirect/Direct Support Costs)					
Other Transfers Out					
All Other Transfers Out to All Others		7299	0.00	0.00	0.0%
Debt Service					
Debt Service - Interest		7438	0.00	0.00	0.0%
Other Debt Service - Principal		7439	258,320.00	258,320.00	0.0%
TOTAL, OTHER OUTGO (excluding Transfers of Indirect/Direct Support Costs)			258,320.00	258,320.00	0.0%
TRANSFERS OF INDIRECT/DIRECT SUPPORT COSTS					
Transfers of Direct Support Costs - Interfund		7380	0.00	0.00	0.0%
TOTAL, TRANSFERS OF INDIRECT/DIRECT SUPPORT COSTS			0.00	0.00	0.0%
TOTAL, EXPENDITURES			1,836,255.00	2,168,607.00	18.1%

July 1 Budget (Single Adoption)
 Capital Facilities Fund
 Expenditures by Object

Orange Unified
 Orange County

30 66621 0000000
 Form 25

Description	Resource Codes	Object Codes	2006-07 Estimated Actuals	2007-08 Budget	Percent Difference
INTERFUND TRANSFERS					
INTERFUND TRANSFERS IN					
Other Authorized Interfund Transfers In		8919	0.00	0.00	0.0%
(a) TOTAL, INTERFUND TRANSFERS IN			0.00	0.00	0.0%
INTERFUND TRANSFERS OUT					
To: State School Building Fund/ County School Facilities Fund		7613	0.00	0.00	0.0%
Other Authorized Interfund Transfers Out		7619	0.00	0.00	0.0%
(b) TOTAL, INTERFUND TRANSFERS OUT			0.00	0.00	0.0%
OTHER SOURCES/USES					
SOURCES					
Proceeds					
Proceeds from Sale/Lease- Purchase of Land/Buildings		8953	0.00	0.00	0.0%
Other Sources					
Transfers from Funds of Lapsed/Reorganized LEAs		8965	0.00	0.00	0.0%
Long-Term Debt Proceeds					
Proceeds from Certificates of Participation		8971	0.00	0.00	0.0%
Proceeds from Capital Leases		8972	0.00	0.00	0.0%
Proceeds from Lease Revenue Bonds		8973	0.00	0.00	0.0%
All Other Financing Sources		8979	0.00	0.00	0.0%
(c) TOTAL, SOURCES			0.00	0.00	0.0%
USES					
Transfers from Funds of Lapsed/Reorganized LEAs		7651	0.00	0.00	0.0%
All Other Financing Uses		7699	0.00	0.00	0.0%
(d) TOTAL, USES			0.00	0.00	0.0%
CONTRIBUTIONS					
Contributions from Unrestricted Revenues		8980	0.00	0.00	0.0%
Contributions from Restricted Revenues		8990	0.00	0.00	0.0%
(e) TOTAL, CONTRIBUTIONS			0.00	0.00	0.0%
TOTAL, OTHER FINANCING SOURCES/USES (a - b + c - d + e)			0.00	0.00	0.0%

July 1 Budget (Single Adoption)
 County School Facilities Fund
 Expenditures by Object

Orange Unified
 Orange County

30 66621 000000
 Form 35

Description	Resource Codes	Object Codes	2006-07 Estimated Actuals	2007-08 Budget	Percent Difference
A. REVENUES					
1) Revenue Limit Sources		8010-8099	0.00	0.00	0.0%
2) Federal Revenue		8100-8299	0.00	0.00	0.0%
3) Other State Revenue		8300-8599	762,000.00	0.00	-100.0%
4) Other Local Revenue		8600-8799	109,535.00	89,000.00	-18.7%
5) TOTAL, REVENUES			871,535.00	89,000.00	-89.8%
B. EXPENDITURES					
1) Certificated Salaries		1000-1999	0.00	0.00	0.0%
2) Classified Salaries		2000-2999	0.00	0.00	0.0%
3) Employee Benefits		3000-3999	0.00	0.00	0.0%
4) Books and Supplies		4000-4999	132,042.00	0.00	-100.0%
5) Services and Other Operating Expenditures		5000-5999	2,596.00	1,900.00	-26.8%
6) Capital Outlay		6000-6999	218,575.00	1,733,213.00	693.0%
7) Other Outgo (excluding Transfers of Indirect/Direct Support Costs)		7100-7299, 7400-7499	0.00	0.00	0.0%
8) Transfers of Indirect/Direct Support Costs		7300-7399	0.00	0.00	0.0%
9) TOTAL, EXPENDITURES			353,213.00	1,735,113.00	391.2%
C. EXCESS (DEFICIENCY) OF REVENUES OVER EXPENDITURES BEFORE OTHER FINANCING SOURCES AND USES (A5 - B9)					
			518,322.00	(1,646,113.00)	-417.6%
D. OTHER FINANCING SOURCES/USES					
1) Interfund Transfers					
a) Transfers In		8910-8929	0.00	0.00	0.0%
b) Transfers Out		7610-7629	765,161.00	0.00	-100.0%
2) Other Sources/Uses					
a) Sources		8930-8979	0.00	0.00	0.0%
b) Uses		7630-7699	0.00	0.00	0.0%
3) Contributions		8980-8999	0.00	0.00	0.0%
4) TOTAL, OTHER FINANCING SOURCES/USES			(765,161.00)	0.00	-100.0%

July 1 Budget (Single Adoption)
 County School Facilities Fund
 Expenditures by Object

Orange Unified
 Orange County

30 66621 000000
 Form 35

Description	Resource Codes	Object Codes	2006-07 Estimated Actuals	2007-08 Budget	Percent Difference
E. NET INCREASE (DECREASE) IN FUND BALANCE (C + D4)			(246,839.00)	(1,646,113.00)	566.9%
F. FUND BALANCE, RESERVES					
1) Beginning Fund Balance					
a) As of July 1 - Unaudited		9791	1,892,952.86	1,646,113.86	-13.0%
b) Audit Adjustments		9793	0.00	0.00	0.0%
c) As of July 1 - Audited (F1a + F1b)			1,892,952.86	1,646,113.86	-13.0%
d) Other Restatements		9795	0.00	0.00	0.0%
e) Adjusted Beginning Balance (F1c + F1d)			1,892,952.86	1,646,113.86	-13.0%
2) Ending Balance, June 30 (E + F1e)					
Components of Ending Fund Balance					
a) Reserve for					
Revolving Cash		9711	0.00	0.00	0.0%
Stores		9712	0.00	0.00	0.0%
Prepaid Expenditures		9713	0.00	0.00	0.0%
All Others		9719	0.00	0.00	0.0%
General Reserve		9730	0.00	0.00	0.0%
Legally Restricted Balance		9740	0.00	0.00	0.0%
b) Designated Amounts					
Designated for Economic Uncertainties		9770	0.00	0.00	0.0%
Designated for the Unrealized Gains of Investments and Cash in County Treasury		9775	0.00	0.00	0.0%
Other Designations		9780	1,646,113.68	0.00	-100.0%
La Veta Modernization - District Match	0000	9780	824,867.19		
McPherson Modernization - District Match	0000	9780	821,246.49		
c) Undesignated Amount		9790	0.18		
d) Unappropriated Amount		9790		0.86	

July 1 Budget (Single Adoption)
 County School Facilities Fund
 Expenditures by Object

Orange Unified
 Orange County

30 66621 0000000
 Form 35

Description	Resource Codes	Object Codes	2006-07 Estimated Actuals	2007-08 Budget	Percent Difference
FEDERAL REVENUE					
Other Federal Revenue		8290	0.00	0.00	0.0%
TOTAL, FEDERAL REVENUE			0.00	0.00	0.0%
OTHER STATE REVENUE					
School Facilities Apportionments		8545	762,000.00	0.00	-100.0%
Pass-Through Revenues from State Sources		8587	0.00	0.00	0.0%
All Other State Revenue		8590	0.00	0.00	0.0%
TOTAL, OTHER STATE REVENUE			762,000.00	0.00	-100.0%
OTHER LOCAL REVENUE					
Sales					
Sale of Equipment/Supplies		8631	0.00	0.00	0.0%
Leases and Rentals		8650	0.00	0.00	0.0%
Interest		8660	109,535.00	89,000.00	-18.7%
Net Increase (Decrease) in the Fair Value of Investments		8662	0.00	0.00	0.0%
Other Local Revenue					
All Other Local Revenue		8699	0.00	0.00	0.0%
All Other Transfers In From All Others		8799	0.00	0.00	0.0%
TOTAL, OTHER LOCAL REVENUE			109,535.00	89,000.00	-18.7%
TOTAL, REVENUES			871,535.00	89,000.00	-89.8%

July 1 Budget (Single Adoption)
 County School Facilities Fund
 Expenditures by Object

Orange Unified
 Orange County

30 66621 000000
 Form 35

Description	Resource Codes	Object Codes	2006-07 Estimated Actuals	2007-08 Budget	Percent Difference
CLASSIFIED SALARIES					
Classified Support Salaries		2200	0.00	0.00	0.0%
Classified Supervisors' and Administrators' Salaries		2300	0.00	0.00	0.0%
Clerical, Technical and Office Salaries		2400	0.00	0.00	0.0%
Other Classified Salaries		2900	0.00	0.00	0.0%
TOTAL, CLASSIFIED SALARIES			0.00	0.00	0.0%
EMPLOYEE BENEFITS					
STRS		3101-3102	0.00	0.00	0.0%
PERS		3201-3202	0.00	0.00	0.0%
OASDI/Medicare/Alternative		3301-3302	0.00	0.00	0.0%
Health and Welfare Benefits		3401-3402	0.00	0.00	0.0%
Unemployment Insurance		3501-3502	0.00	0.00	0.0%
Workers' Compensation		3601-3602	0.00	0.00	0.0%
OPEB, Allocated		3701-3702	0.00	0.00	0.0%
OPEB, Active Employees		3751-3752		0.00	
PERS Reduction		3801-3802	0.00	0.00	0.0%
Other Employee Benefits		3901-3902	0.00	0.00	0.0%
TOTAL, EMPLOYEE BENEFITS			0.00	0.00	0.0%
BOOKS AND SUPPLIES					
Books and Other Reference Materials		4200	0.00	0.00	0.0%
Materials and Supplies		4300	132,042.00	0.00	-100.0%
Noncapitalized Equipment		4400	0.00	0.00	0.0%
TOTAL, BOOKS AND SUPPLIES			132,042.00	0.00	-100.0%

July 1 Budget (Single Adoption)
 County School Facilities Fund
 Expenditures by Object

Orange Unified
 Orange County

30 66621 000000
 Form 35

Description	Resource Codes	Object Codes	2006-07 Estimated Actuals	2007-08 Budget	Percent Difference
SERVICES AND OTHER OPERATING EXPENDITURES					
Subagreements for Services		5100		0.00	
Travel and Conferences		5200	0.00	0.00	0.0%
Insurance		5400-5450	0.00	0.00	0.0%
Operations and Housekeeping Services		5500	0.00	0.00	0.0%
Rentals, Leases, Repairs, and Noncapitalized Improvements		5600	0.00	0.00	0.0%
Transfers of Direct Costs		5710	0.00	0.00	0.0%
Transfers of Direct Costs - Interfund		5750	0.00	0.00	0.0%
Professional/Consulting Services and Operating Expenditures		5800	2,596.00	1,900.00	-26.8%
Communications		5900	0.00	0.00	0.0%
TOTAL, SERVICES AND OTHER OPERATING EXPENDITURES			2,596.00	1,900.00	-26.8%
CAPITAL OUTLAY					
Land		6100	0.00	0.00	0.0%
Land Improvements		6170	0.00	0.00	0.0%
Buildings and Improvements of Buildings		6200	218,575.00	1,733,213.00	693.0%
Books and Media for New School Libraries or Major Expansion of School Libraries		6300	0.00	0.00	0.0%
Equipment		6400	0.00	0.00	0.0%
Equipment Replacement		6500	0.00	0.00	0.0%
TOTAL, CAPITAL OUTLAY			218,575.00	1,733,213.00	693.0%
OTHER OUTGO (excluding Transfers of Indirect/Direct Support Costs)					
Other Transfers Out					
Transfers of Pass-Through Revenues To Districts or Charter Schools		7211	0.00	0.00	0.0%
To County Offices		7212	0.00	0.00	0.0%
To JPAs		7213	0.00	0.00	0.0%
All Other Transfers Out to All Others		7299	0.00	0.00	0.0%
Debt Service					
Debt Service - Interest		7438	0.00	0.00	0.0%
Other Debt Service - Principal		7439	0.00	0.00	0.0%
TOTAL, OTHER OUTGO (excluding Transfers of Indirect/Direct Support Costs)			0.00	0.00	0.0%
TOTAL EXPENDITURES			353,213.00	1,735,113.00	391.2%

July 1 Budget (Single Adoption)
 County School Facilities Fund
 Expenditures by Object

Orange Unified
 Orange County

30 66621 0000000
 Form 35

Description	Resource Codes	Object Codes	2006-07 Estimated Actuals	2007-08 Budget	Percent Difference
INTERFUND TRANSFERS					
INTERFUND TRANSFERS IN					
To: State School Building Fund/ County School Facilities Fund From: All Other Funds		8913	0.00	0.00	0.0%
Other Authorized Interfund Transfers In		8919	0.00	0.00	0.0%
(a) TOTAL, INTERFUND TRANSFERS IN			0.00	0.00	0.0%
INTERFUND TRANSFERS OUT					
To: State School Building Fund/ County School Facilities Fund		7613	0.00	0.00	0.0%
Other Authorized Interfund Transfers Out		7619	765,161.00	0.00	-100.0%
(b) TOTAL, INTERFUND TRANSFERS OUT			765,161.00	0.00	-100.0%

July 1 Budget (Single Adoption)
 Orange Unified
 Orange County
 County School Facilities Fund
 Expenditures by Object

30 66621 000000
 Form 35

Description	Resource Codes	Object Codes	2006-07 Estimated Actuals	2007-08 Budget	Percent Difference
OTHER SOURCES/USES					
SOURCES					
Proceeds					
Proceeds from Sale/Lease- Purchase of Land/Buildings		8953	0.00	0.00	0.0%
Other Sources					
Transfers from Funds of Lapsed/Reorganized LEAs		8965	0.00	0.00	0.0%
Long-Term Debt Proceeds					
Proceeds from Certificates of Participation		8971	0.00	0.00	0.0%
Proceeds from Capital Leases		8972	0.00	0.00	0.0%
Proceeds from Lease Revenue Bonds		8973	0.00	0.00	0.0%
All Other Financing Sources		8979	0.00	0.00	0.0%
(c) TOTAL, SOURCES			0.00	0.00	0.0%
USES					
Transfers from Funds of Lapsed/Reorganized LEAs		7651	0.00	0.00	0.0%
(d) TOTAL, USES			0.00	0.00	0.0%
CONTRIBUTIONS					
Contributions from Unrestricted Revenues		8980	0.00	0.00	0.0%
Contributions from Restricted Revenues		8990	0.00	0.00	0.0%
Categorical Education Block Grant Transfers		8995	0.00	0.00	0.0%
(e) TOTAL, CONTRIBUTIONS			0.00	0.00	0.0%
TOTAL, OTHER FINANCING SOURCES/USES (a - b + c - d + e)			(765,161.00)	0.00	-100.0%

July 1 Budget (Single Adoption)
Special Reserve Fund for Capital Outlay Projects
Expenditures by Object

Description	Resource Codes	Object Codes	2006-07 Estimated Actuals	2007-08 Budget	Percent Difference
A. REVENUES					
1) Revenue Limit Sources		8010-8099	0.00	0.00	0.0%
2) Federal Revenue		8100-8299	0.00	0.00	0.0%
3) Other State Revenue		8300-8599	0.00	0.00	0.0%
4) Other Local Revenue		8600-8799	778,085.00	365,000.00	-53.1%
5) TOTAL, REVENUES			778,085.00	365,000.00	-53.1%
B. EXPENDITURES					
1) Certificated Salaries		1000-1999	0.00	0.00	0.0%
2) Classified Salaries		2000-2999	1,978.00	3,000.00	51.7%
3) Employee Benefits		3000-3999	208.00	317.00	52.4%
4) Books and Supplies		4000-4999	335.00	0.00	-100.0%
5) Services and Other Operating Expenditures		5000-5999	12,261.00	1,007,800.00	8119.6%
6) Capital Outlay		6000-6999	233,330.00	0.00	-100.0%
7) Other Outgo (excluding Transfers of Indirect/Direct Support Costs)		7100-7299, 7400-7499	15,102.00	15,102.00	0.0%
8) Transfers of Indirect/Direct Support Costs		7300-7399	0.00	0.00	0.0%
9) TOTAL, EXPENDITURES			263,214.00	1,026,219.00	289.9%
C. EXCESS (DEFICIENCY) OF REVENUES OVER EXPENDITURES BEFORE OTHER FINANCING SOURCES AND USES (A5 - B9)			514,871.00	(661,219.00)	-228.4%
D. OTHER FINANCING SOURCES/USES					
1) Interfund Transfers					
a) Transfers In		8910-8929	41,972.00	0.00	-100.0%
b) Transfers Out		7610-7629	29,676.00	0.00	-100.0%
2) Other Sources/Uses					
a) Sources		8930-8979	0.00	0.00	0.0%
b) Uses		7630-7699	0.00	0.00	0.0%
3) Contributions		8980-8999	0.00	0.00	0.0%
4) TOTAL, OTHER FINANCING SOURCES/USES			12,296.00	0.00	-100.0%

July 1 Budget (Single Adoption)
Special Reserve Fund for Capital Outlay Projects
Expenditures by Object

Description	Resource Codes	Object Codes	2006-07 Estimated Actuals	2007-08 Budget	Percent Difference
E. NET INCREASE (DECREASE) IN FUND BALANCE (C + D4)			527,167.00	(661,219.00)	-225.4%
F. FUND BALANCE, RESERVES					
1) Beginning Fund Balance					
a) As of July 1 - Unaudited		9791	7,358,604.98	7,885,771.98	7.2%
b) Audit Adjustments		9793	0.00	0.00	0.0%
c) As of July 1 - Audited (F1a + F1b)			7,358,604.98	7,885,771.98	7.2%
d) Other Restatements		9795	0.00	0.00	0.0%
e) Adjusted Beginning Balance (F1c + F1d)			7,358,604.98	7,885,771.98	7.2%
2) Ending Balance, June 30 (E + F1e)					
Components of Ending Fund Balance					
a) Reserve for					
Revolving Cash		9711	0.00	0.00	0.0%
Stores		9712	0.00	0.00	0.0%
Prepaid Expenditures		9713	0.00	0.00	0.0%
All Others		9719	0.00	0.00	0.0%
General Reserve		9730	0.00	0.00	0.0%
Legally Restricted Balance		9740	0.00	0.00	0.0%
b) Designated Amounts					
Designated for Economic Uncertainties		9770	0.00	0.00	0.0%
Designated for the Unrealized Gains of Investments and Cash in County Treasury		9775	0.00	0.00	0.0%
Other Designations		9780	7,885,771.98	7,224,552.98	-8.4%
Special Reserve - Capital Projects	0000	9780		6,424,552.98	
Kelly Field Refurbishment	0000	9780		800,000.00	
Special Reserve-Capital Projects	0000	9780	6,025,747.98		
Yorba - Grounds	0000	9780	60,024.00		
Anaheim Hills School Site Project	0000	9780	1,000,000.00		
Kelly Field Refurbishment	0000	9780	800,000.00		
c) Undesignated Amount					
		9790	0.00		
d) Unappropriated Amount					
		9790		0.00	

Description	Resource Codes	Object Codes	2006-07 Estimated Actuals	2007-08 Budget	Percent Difference
FEDERAL REVENUE					
FEMA		8281	0.00	0.00	0.0%
Other Federal Revenue		8290	0.00	0.00	0.0%
TOTAL, FEDERAL REVENUE			0.00	0.00	0.0%
OTHER STATE REVENUE					
Pass-Through Revenues from State Sources		8587	0.00	0.00	0.0%
All Other State Revenue		8590	0.00	0.00	0.0%
TOTAL, OTHER STATE REVENUE			0.00	0.00	0.0%
OTHER LOCAL REVENUE					
Other Local Revenue					
Community Redevelopment Funds Not Subject to RL Deduction		8625	342,268.00	0.00	-100.0%
Sales					
Sale of Equipment/Supplies		8631	0.00	0.00	0.0%
Leases and Rentals		8650	172,724.00	146,000.00	-15.5%
Interest		8660	259,093.00	219,000.00	-15.5%
Net Increase (Decrease) in the Fair Value of Investments		8662	0.00	0.00	0.0%
Other Local Revenue					
All Other Local Revenue		8699	4,000.00	0.00	-100.0%
All Other Transfers In From All Others		8799	0.00	0.00	0.0%
TOTAL, OTHER LOCAL REVENUE			778,085.00	365,000.00	-53.1%
TOTAL, REVENUES			778,085.00	365,000.00	-53.1%

Description	Resource Codes	Object Codes	2006-07 Estimated Actuals	2007-08 Budget	Percent Difference
CLASSIFIED SALARIES					
Classified Support Salaries		2200	1,978.00	3,000.00	51.7%
Classified Supervisors' and Administrators' Salaries		2300	0.00	0.00	0.0%
Clerical, Technical and Office Salaries		2400	0.00	0.00	0.0%
Other Classified Salaries		2900	0.00	0.00	0.0%
TOTAL, CLASSIFIED SALARIES			1,978.00	3,000.00	51.7%
EMPLOYEE BENEFITS					
STRS		3101-3102	0.00	0.00	0.0%
PERS		3201-3202	0.00	0.00	0.0%
OASDI/Medicare/Alternative		3301-3302	152.00	230.00	51.3%
Health and Welfare Benefits		3401-3402	0.00	0.00	0.0%
Unemployment Insurance		3501-3502	1.00	2.00	100.0%
Workers' Compensation		3601-3602	55.00	50.00	-9.1%
OPEB, Allocated		3701-3702	0.00	35.00	New
OPEB, Active Employees		3751-3752		0.00	
PERS Reduction		3801-3802	0.00	0.00	0.0%
Other Employee Benefits		3901-3902	0.00	0.00	0.0%
TOTAL, EMPLOYEE BENEFITS			208.00	317.00	52.4%
BOOKS AND SUPPLIES					
Books and Other Reference Materials		4200	0.00	0.00	0.0%
Materials and Supplies		4300	335.00	0.00	-100.0%
Noncapitalized Equipment		4400	0.00	0.00	0.0%
TOTAL, BOOKS AND SUPPLIES			335.00	0.00	-100.0%

Description	Resource Codes	Object Codes	2006-07 Estimated Actuals	2007-08 Budget	Percent Difference
SERVICES AND OTHER OPERATING EXPENDITURES					
Subagreements for Services		5100		0.00	
Travel and Conferences		5200	0.00	0.00	0.0%
Insurance		5400-5450	0.00	0.00	0.0%
Operations and Housekeeping Services		5500	0.00	0.00	0.0%
Rentals, Leases, Repairs, and Noncapitalized Improvements		5600	3,629.00	1,000,000.00	27455.8%
Transfers of Direct Costs		5710	0.00	0.00	0.0%
Transfers of Direct Costs - Interfund		5750	0.00	0.00	0.0%
Professional/Consulting Services and Operating Expenditures		5800	8,627.00	7,800.00	-9.6%
Communications		5900	5.00	0.00	-100.0%
TOTAL, SERVICES AND OTHER OPERATING EXPENDITURES			12,261.00	1,007,800.00	8119.6%
CAPITAL OUTLAY					
Land		6100	47,125.00	0.00	-100.0%
Land Improvements		6170	0.00	0.00	0.0%
Buildings and Improvements of Buildings		6200	186,205.00	0.00	-100.0%
Books and Media for New School Libraries or Major Expansion of School Libraries		6300	0.00	0.00	0.0%
Equipment		6400	0.00	0.00	0.0%
Equipment Replacement		6500	0.00	0.00	0.0%
TOTAL, CAPITAL OUTLAY			233,330.00	0.00	-100.0%
OTHER OUTGO (excluding Transfers of Indirect/Direct Support Costs)					
Other Transfers Out					
Transfers of Pass-Through Revenues					
To Districts or Charter Schools		7211	0.00	0.00	0.0%
To County Offices		7212	0.00	0.00	0.0%
To JPAs		7213	0.00	0.00	0.0%
All Other Transfers Out to All Others		7299	0.00	0.00	0.0%
Debt Service					
Debt Service - Interest		7438	0.00	0.00	0.0%
Other Debt Service - Principal		7439	15,102.00	15,102.00	0.0%
TOTAL, OTHER OUTGO (excluding Transfers of Indirect/Direct Support Costs)			15,102.00	15,102.00	0.0%
TOTAL EXPENDITURES			263,214.00	1,026,219.00	289.9%

Description	Resource Codes	Object Codes	2006-07 Estimated Actuals	2007-08 Budget	Percent Difference
INTERFUND TRANSFERS					
INTERFUND TRANSFERS IN					
From: General Fund/CSSF		8912	41,972.00	0.00	-100.0%
Other Authorized Interfund Transfers In		8919	0.00	0.00	0.0%
(a) TOTAL, INTERFUND TRANSFERS IN			41,972.00	0.00	-100.0%
INTERFUND TRANSFERS OUT					
To: General Fund/CSSF		7612	29,676.00	0.00	-100.0%
To: State School Building Fund/ County School Facilities Fund		7613	0.00	0.00	0.0%
To: Deferred Maintenance Fund		7615	0.00	0.00	0.0%
Other Authorized Interfund Transfers Out		7619	0.00	0.00	0.0%
(b) TOTAL, INTERFUND TRANSFERS OUT			29,676.00	0.00	-100.0%

Description	Resource Codes	Object Codes	2006-07 Estimated Actuals	2007-08 Budget	Percent Difference
OTHER SOURCES/USES					
SOURCES					
Proceeds					
Proceeds from Sale/Lease-Purchase of Land/Buildings		8953	0.00	0.00	0.0%
Other Sources					
Transfers from Funds of Lapsed/Reorganized LEAs		8965	0.00	0.00	0.0%
Long-Term Debt Proceeds					
Proceeds from Certificates of Participation		8971	0.00	0.00	0.0%
Proceeds from Capital Leases		8972	0.00	0.00	0.0%
Proceeds from Lease Revenue Bonds		8973	0.00	0.00	0.0%
All Other Financing Sources		8979	0.00	0.00	0.0%
(c) TOTAL, SOURCES			0.00	0.00	0.0%
USES					
Transfers from Funds of Lapsed/Reorganized LEAs		7651	0.00	0.00	0.0%
All Other Financing Uses		7699	0.00	0.00	0.0%
(d) TOTAL, USES			0.00	0.00	0.0%
CONTRIBUTIONS					
Contributions from Unrestricted Revenues		8980	0.00	0.00	0.0%
Contributions from Restricted Revenues		8990	0.00	0.00	0.0%
Categorical Education Block Grant Transfers		8995	0.00	0.00	0.0%
(e) TOTAL, CONTRIBUTIONS			0.00	0.00	0.0%
TOTAL, OTHER FINANCING SOURCES/USES (a - b + c - d + e)			12,296.00	0.00	-100.0%

July 1 Budget (Single Adoption)
Debt Service Fund
Expenditures by Object

Orange Unified
Orange County

30 66621 000000
Form 56

Description	Resource Codes	Object Codes	2006-07 Estimated Actuals	2007-08 Budget	Percent Difference
B. REVENUES					
1) Revenue Limit Sources		8010-8099	0.00	0.00	0.0%
2) Federal Revenue		8100-8299	0.00	0.00	0.0%
3) Other State Revenue		8300-8599	0.00	0.00	0.0%
4) Other Local Revenue		8600-8799	3,188,483.00	3,334,000.00	4.6%
5) TOTAL, REVENUES			3,188,483.00	3,334,000.00	4.6%
B. EXPENDITURES					
1) Certificated Salaries		1000-1999	0.00	0.00	0.0%
2) Classified Salaries		2000-2999	0.00	0.00	0.0%
3) Employee Benefits		3000-3999	0.00	0.00	0.0%
4) Books and Supplies		4000-4999	0.00	0.00	0.0%
5) Services and Other Operating Expenditures		5000-5999	0.00	0.00	0.0%
6) Capital Outlay		6000-6999	0.00	0.00	0.0%
7) Other Outgo (excluding Transfers of Indirect/Direct Support Costs)		7100-7299, 7400-7499	2,810,584.00	2,934,718.00	4.4%
8) Transfers of Indirect/Direct Support Costs		7300-7399	0.00	0.00	0.0%
9) TOTAL, EXPENDITURES			2,810,584.00	2,934,718.00	4.4%
C. EXCESS (DEFICIENCY) OF REVENUES OVER EXPENDITURES BEFORE OTHER FINANCING SOURCES AND USES (A5 - B9)			377,899.00	399,282.00	5.7%
D. OTHER FINANCING SOURCES/USES					
1) Interfund Transfers					
a) Transfers In		8910-8929	0.00	0.00	0.0%
b) Transfers Out		7610-7629	0.00	0.00	0.0%
2) Other Sources/Uses					
a) Sources		8930-8979	0.00	0.00	0.0%
b) Uses		7630-7699	0.00	0.00	0.0%
3) Contributions		8980-8999	0.00	0.00	0.0%
4) TOTAL, OTHER FINANCING SOURCES/USES			0.00	0.00	0.0%

July 1 Budget (Single Adoption)
Debt Service Fund
Expenditures by Object

Orange Unified
Orange County

30 66621 000000
Form 56

Description	Resource Codes	Object Codes	2006-07 Estimated Actuals	2007-08 Budget	Percent Difference
E. NET INCREASE (DECREASE) IN FUND BALANCE (C + D4)			377,899.00	399,282.00	5.7%
F. FUND BALANCE, RESERVES					
1) Beginning Fund Balance					
a) As of July 1 - Unaudited		9791	4,090,902.97	4,468,801.97	9.2%
b) Audit Adjustments		9793	0.00	0.00	0.0%
c) As of July 1 - Audited (F1a + F1b)			4,090,902.97	4,468,801.97	9.2%
d) Other Restatements		9795	0.00	0.00	0.0%
e) Adjusted Beginning Balance (F1c + F1d)			4,090,902.97	4,468,801.97	9.2%
2) Ending Balance, June 30 (E + F1e)					
Components of Ending Fund Balance					
a) Reserve for					
Revolving Cash		9711	0.00	0.00	0.0%
Stores		9712	0.00	0.00	0.0%
Prepaid Expenditures		9713	0.00	0.00	0.0%
All Others		9719	0.00	0.00	0.0%
General Reserve		9730	0.00	0.00	0.0%
Legally Restricted Balance		9740	0.00	0.00	0.0%
b) Designated Amounts					
Designated for Economic Uncertainties		9770	0.00	0.00	0.0%
Designated for the Unrealized Gains of Investments and Cash in County Treasury		9775	0.00	0.00	0.0%
Other Designations		9780	0.00	0.00	0.0%
c) Undesignated Amount		9790	4,468,801.97		
d) Unappropriated Amount		9790		4,868,083.97	

July 1 Budget (Single Adoption)
Debt Service Fund
Expenditures by Object

Orange Unified
Orange County

30 66621 0000000
Form 56

Description	Resource Codes	Object Codes	2006-07 Estimated Actuals	2007-08 Budget	Percent Difference
FEDERAL REVENUE					
Other Federal Revenue		8290	0.00	0.00	0.0%
TOTAL, FEDERAL REVENUE			0.00	0.00	0.0%
OTHER STATE REVENUE					
All Other State Revenue		8590	0.00	0.00	0.0%
TOTAL, OTHER STATE REVENUE			0.00	0.00	0.0%
OTHER LOCAL REVENUE					
Interest		8660	259,703.00	250,000.00	-3.7%
Net Increase (Decrease) in the Fair Value of Investments		8662	0.00	0.00	0.0%
Other Local Revenue					
All Other Local Revenue		8699	2,928,780.00	3,084,000.00	5.3%
TOTAL, OTHER LOCAL REVENUE			3,188,483.00	3,334,000.00	4.6%
TOTAL, REVENUES			3,188,483.00	3,334,000.00	4.6%
OTHER OUTGO (excluding Transfers of Indirect/Direct Support Costs)					
Debt Service					
Debt Service - Interest		7438	0.00	0.00	0.0%
Other Debt Service - Principal		7439	2,810,584.00	2,934,718.00	4.4%
TOTAL, OTHER OUTGO (excluding Transfers of Indirect/Direct Support Costs)			2,810,584.00	2,934,718.00	4.4%
TOTAL, EXPENDITURES			2,810,584.00	2,934,718.00	4.4%

July 1 Budget (Single Adoption)
Debt Service Fund
Expenditures by Object

Orange Unified
Orange County

30 66621 0000000
Form 56

Description	Resource Codes	Object Codes	2006-07 Estimated Actuals	2007-08 Budget	Percent Difference
INTERFUND TRANSFERS					
INTERFUND TRANSFERS IN					
Other Authorized Interfund Transfers In		8919	0.00	0.00	0.0%
(a) TOTAL, INTERFUND TRANSFERS IN			0.00	0.00	0.0%
INTERFUND TRANSFERS OUT					
Other Authorized Interfund Transfers Out		7619	0.00	0.00	0.0%
(b) TOTAL, INTERFUND TRANSFERS OUT			0.00	0.00	0.0%
OTHER SOURCES/USES					
SOURCES					
Other Sources					
Transfers from Funds of Lapsed/Reorganized LEAs		8965	0.00	0.00	0.0%
Long-Term Debt Proceeds					
Proceeds from Certificates of Participation		8971	0.00	0.00	0.0%
(c) TOTAL, SOURCES			0.00	0.00	0.0%
USES					
Transfers from Funds of Lapsed/Reorganized LEAs		7651	0.00	0.00	0.0%
(d) TOTAL, USES			0.00	0.00	0.0%
TOTAL, OTHER FINANCING SOURCES/USES (a - b + c - d)			0.00	0.00	0.0%

July 1 Budget (Single Adoption)
Self-Insurance Fund
Expenses by Object

Orange Unified
Orange County

30 66621 000000
Form 67

Description	Resource Codes	Object Codes	2006-07 Estimated Actuals	2007-08 Budget	Percent Difference
B. REVENUES					
1) Revenue Limit Sources		8010-8099	0.00	0.00	0.0%
2) Federal Revenue		8100-8299	0.00	0.00	0.0%
3) Other State Revenue		8300-8599	0.00	0.00	0.0%
4) Other Local Revenue		8600-8799	3,914,978.00	3,225,000.00	-17.6%
5) TOTAL, REVENUES			3,914,978.00	3,225,000.00	-17.6%
C. EXPENSES					
1) Certificated Salaries		1000-1999	0.00	0.00	0.0%
2) Classified Salaries		2000-2999	140,832.00	145,059.00	3.0%
3) Employee Benefits		3000-3999	45,065.00	52,042.00	15.5%
4) Books and Supplies		4000-4999	500.00	3,500.00	600.0%
5) Services and Other Operating Expenses		5000-5999	1,463,905.00	1,281,000.00	-12.5%
6) Depreciation		6000-6999	0.00	0.00	0.0%
7) Other Outgo (excluding Transfers of Indirect/Direct Support Costs)		7100-7299, 7400-7499	0.00	0.00	0.0%
8) Transfers of Indirect/Direct Support Costs		7300-7399	0.00	0.00	0.0%
9) TOTAL, EXPENSES			1,650,302.00	1,481,601.00	-10.2%
C. EXCESS (DEFICIENCY) OF REVENUES OVER EXPENSES BEFORE OTHER FINANCING SOURCES AND USES (A5 - B9)			2,264,676.00	1,743,399.00	-23.0%
D. OTHER FINANCING SOURCES/USES					
1) Interfund Transfers					
a) Transfers In		8910-8929	0.00	0.00	0.0%
b) Transfers Out		7610-7629	0.00	0.00	0.0%
2) Other Sources/Uses					
a) Sources		8930-8979	0.00	0.00	0.0%
b) Uses		7630-7699	0.00	0.00	0.0%
3) Contributions		8980-8999	0.00	0.00	0.0%
4) TOTAL, OTHER FINANCING SOURCES/USES			0.00	0.00	0.0%

Description	Resource Codes	Object Codes	2006-07 Estimated Actuals	2007-08 Budget	Percent Difference
D. NET INCREASE (DECREASE) IN NET ASSETS (C + D4)			2,264,676.00	1,743,399.00	-23.0%
E. NET ASSETS					
1) Beginning Net Assets					
a) As of July 1 - Unaudited		9791	5,178,510.73	7,443,186.73	43.7%
b) Audit Adjustments		9793	0.00	0.00	0.0%
c) As of July 1 - Audited (F1a + F1b)			5,178,510.73	7,443,186.73	43.7%
d) Other Restatements		9795	0.00	0.00	0.0%
e) Adjusted Beginning Net Assets (F1c + F1d)			5,178,510.73	7,443,186.73	43.7%
2) Ending Net Assets, June 30 (E + F1e)					
Components of Ending Net Assets					
a) Reserve for					
Revolving Cash		9711	0.00	0.00	0.0%
Stores		9712	0.00	0.00	0.0%
Prepaid Expenditures		9713	0.00	0.00	0.0%
All Others		9719	0.00	0.00	0.0%
General Reserve		9730	0.00	0.00	0.0%
Legally Restricted Balance		9740	0.00	0.00	0.0%
b) Designated Amounts					
Designated for Economic Uncertainties		9770	0.00	0.00	0.0%
Designated for the Unrealized Gains of Investments and Cash in County Treasury		9775	0.00	0.00	0.0%
Other Designations		9780	7,443,186.73	9,186,585.73	23.4%
Workers' Compensation	0000	9780		9,186,585.73	
Workers' Compensation	0000	9780	7,443,186.73		
c) Undesignated Amount		9790	0.00		
d) Unappropriated Amount		9790		0.00	

July 1 Budget (Single Adoption)
 Self-Insurance Fund
 Expenses by Object

Orange Unified
 Orange County

30 66621 000000
 Form 67

Description	Resource Codes	Object Codes	2006-07 Estimated Actuals	2007-08 Budget	Percent Difference
OTHER LOCAL REVENUE					
Other Local Revenue					
Sales					
Sale of Equipment/Supplies		8631	0.00	0.00	0.0%
Interest		8660	347,770.00	320,000.00	-8.0%
Net Increase (Decrease) in the Fair Value of Investments		8662	0.00	0.00	0.0%
Fees and Contracts					
In-District Premiums/ Contributions		8674	3,567,208.00	2,905,000.00	-18.6%
All Other Fees and Contracts		8689	0.00	0.00	0.0%
Other Local Revenue					
All Other Local Revenue		8699	0.00	0.00	0.0%
All Other Transfers In From All Others		8799	0.00	0.00	0.0%
TOTAL, OTHER LOCAL REVENUE			3,914,978.00	3,225,000.00	-17.6%
TOTAL, REVENUES			3,914,978.00	3,225,000.00	-17.6%

July 1 Budget (Single Adoption)
 Self-Insurance Fund
 Expenses by Object

Orange Unified
 Orange County

30 66621 000000
 Form 67

Description	Resource Codes	Object Codes	2006-07 Estimated Actuals	2007-08 Budget	Percent Difference
CERTIFICATED SALARIES					
Certificated Pupil Support Salaries		1200	0.00	0.00	0.0%
Certificated Supervisors' and Administrators' Salaries		1300	0.00	0.00	0.0%
TOTAL, CERTIFICATED SALARIES			0.00	0.00	0.0%
CLASSIFIED SALARIES					
Classified Support Salaries		2200	0.00	0.00	0.0%
Classified Supervisors' and Administrators' Salaries		2300	90,108.00	92,813.00	3.0%
Clerical, Technical and Office Salaries		2400	50,724.00	52,246.00	3.0%
Other Classified Salaries		2900	0.00	0.00	0.0%
TOTAL, CLASSIFIED SALARIES			140,832.00	145,059.00	3.0%
EMPLOYEE BENEFITS					
STRS		3101-3102	0.00	0.00	0.0%
PERS		3201-3202	16,400.00	16,892.00	3.0%
OASDI/Medicare/Alternative		3301-3302	9,730.00	9,876.00	1.5%
Health and Welfare Benefits		3401-3402	9,446.00	15,502.00	64.1%
Unemployment Insurance		3501-3502	71.00	73.00	2.8%
Workers' Compensation		3601-3602	3,255.00	2,379.00	-26.9%
OPEB, Allocated		3701-3702	675.00	1,668.00	147.1%
OPEB, Active Employees		3751-3752		0.00	
PERS Reduction		3801-3802	5,488.00	5,652.00	3.0%
Other Employee Benefits		3901-3902	0.00	0.00	0.0%
TOTAL, EMPLOYEE BENEFITS			45,065.00	52,042.00	15.5%
BOOKS AND SUPPLIES					
Books and Other Reference Materials		4200	0.00	0.00	0.0%
Materials and Supplies		4300	500.00	1,500.00	200.0%
Noncapitalized Equipment		4400	0.00	2,000.00	New
TOTAL, BOOKS AND SUPPLIES			500.00	3,500.00	600.0%

July 1 Budget (Single Adoption)
 Self-Insurance Fund
 Expenses by Object

Orange Unified
 Orange County

30 66621 000000
 Form 67

Description	Resource Codes	Object Codes	2006-07 Estimated Actuals	2007-08 Budget	Percent Difference
SERVICES AND OTHER OPERATING EXPENSES					
Subagreements for Services		5100		0.00	
Travel and Conferences		5200	0.00	0.00	0.0%
Dues and Memberships		5300	249,539.00	50,000.00	-80.0%
Insurance		5400-5450	480,119.00	525,000.00	9.3%
Operations and Housekeeping Services		5500	0.00	0.00	0.0%
Rentals, Leases, Repairs, and Noncapitalized Improvements		5600	0.00	0.00	0.0%
Transfers of Direct Costs - Interfund		5750	0.00	0.00	0.0%
Professional/Consulting Services and Operating Expenditures		5800	734,247.00	706,000.00	-3.8%
Communications		5900	0.00	0.00	0.0%
TOTAL, SERVICES AND OTHER OPERATING EXPENSES			1,463,905.00	1,281,000.00	-12.5%
DEPRECIATION					
Depreciation Expense		6900	0.00	0.00	0.0%
TOTAL, DEPRECIATION			0.00	0.00	0.0%
TOTAL, EXPENSES			1,650,302.00	1,481,601.00	-10.2%

July 1 Budget (Single Adoption)
 Self-Insurance Fund
 Expenses by Object

Orange Unified
 Orange County

30 66621 0000000
 Form 67

Description	Resource Codes	Object Codes	2006-07 Estimated Actuals	2007-08 Budget	Percent Difference
INTERFUND TRANSFERS					
INTERFUND TRANSFERS IN					
Other Authorized Interfund Transfers In		8919	0.00	0.00	0.0%
(a) TOTAL, INTERFUND TRANSFERS IN			0.00	0.00	0.0%
INTERFUND TRANSFERS OUT					
Other Authorized Interfund Transfers Out		7619	0.00	0.00	0.0%
(b) TOTAL, INTERFUND TRANSFERS OUT			0.00	0.00	0.0%
OTHER SOURCES/USES					
SOURCES					
Other Sources					
Transfers from Funds of Lapsed/Reorganized LEAs		8965	0.00	0.00	0.0%
(c) TOTAL, SOURCES			0.00	0.00	0.0%
USES					
Transfers from Funds of Lapsed/Reorganized LEAs		7651	0.00	0.00	0.0%
(d) TOTAL, USES			0.00	0.00	0.0%
TOTAL, OTHER FINANCING SOURCES/USES (a - b + c - d)			0.00	0.00	0.0%

July 1 Budget (Single Adoption)
 Retiree Benefit Fund
 Expenses by Object

Orange Unified
 Orange County

30 66621 000000
 Form 71

Description	Resource Codes	Object Codes	2006-07 Estimated Actuals	2007-08 Budget	Percent Difference
II. REVENUES					
1) Revenue Limit Sources		8010-8099	0.00	0.00	0.0%
2) Federal Revenue		8100-8299	0.00	0.00	0.0%
3) Other State Revenue		8300-8599	0.00	0.00	0.0%
4) Other Local Revenue		8600-8799	1,431,339.00	1,915,000.00	33.8%
5) TOTAL, REVENUES			1,431,339.00	1,915,000.00	33.8%
III. EXPENSES					
1) Certificated Salaries		1000-1999	0.00	0.00	0.0%
2) Classified Salaries		2000-2999	0.00	0.00	0.0%
3) Employee Benefits		3000-3999	0.00	0.00	0.0%
4) Books and Supplies		4000-4999	0.00	0.00	0.0%
5) Services and Other Operating Expenses		5000-5999	883,852.00	755,772.00	-14.5%
6) Depreciation		6000-6999	0.00	0.00	0.0%
7) Other Outgo (excluding Transfers of Indirect/Direct Support Costs)		7100-7299, 7400-7499	0.00	0.00	0.0%
8) Transfers of Indirect/Direct Support Costs		7300-7399	0.00	0.00	0.0%
9) TOTAL, EXPENSES			883,852.00	755,772.00	-14.5%
IV. EXCESS (DEFICIENCY) OF REVENUES OVER EXPENSES BEFORE OTHER FINANCING SOURCES AND USES (A5 - B9)			547,487.00	1,159,228.00	111.7%
IV. OTHER FINANCING SOURCES/USES					
1) Interfund Transfers					
a) Transfers In		8910-8929	0.00	0.00	0.0%
b) Transfers Out		7610-7629	0.00	0.00	0.0%
2) Other Sources/Uses					
a) Sources		8930-8979	0.00	0.00	0.0%
b) Uses		7630-7699	0.00	0.00	0.0%
3) Contributions		8980-8999	0.00	0.00	0.0%
4) TOTAL, OTHER FINANCING SOURCES/USES			0.00	0.00	0.0%

July 1 Budget (Single Adoption)
 Retiree Benefit Fund
 Expenses by Object

Orange Unified
 Orange County

30 66621 000000
 Form 71

Description	Resource Codes	Object Codes	2006-07 Estimated Actuals	2007-08 Budget	Percent Difference
E. NET INCREASE (DECREASE) IN NET ASSETS (C + D4)			547,487.00	1,159,228.00	111.7%
F. NET ASSETS					
1) Beginning Net Assets					
a) As of July 1 - Unaudited		9791	12,817,976.11	13,365,463.11	4.3%
b) Audit Adjustments		9793	0.00	0.00	0.0%
c) As of July 1 - Audited (F1a + F1b)			12,817,976.11	13,365,463.11	4.3%
d) Other Restatements		9795	0.00	0.00	0.0%
e) Adjusted Beginning Net Assets (F1c + F1d)			12,817,976.11	13,365,463.11	4.3%
2) Ending Net Assets, June 30 (E + F1e)					
Components of Ending Net Assets					
a) Reserve for					
Revolving Cash		9711	0.00	0.00	0.0%
Stores		9712	0.00	0.00	0.0%
Prepaid Expenditures		9713	0.00	0.00	0.0%
All Others		9719	0.00	0.00	0.0%
General Reserve		9730	0.00	0.00	0.0%
Legally Restricted Balance		9740	0.00	0.00	0.0%
b) Designated Amounts					
Designated for Economic Uncertainties		9770	0.00	0.00	0.0%
Designated for the Unrealized Gains of Investments and Cash in County Treasury		9775	0.00	0.00	0.0%
Other Designations		9780	13,365,463.11	14,524,691.11	8.7%
Santiago RMCO Payments	0000	9780		203,790.00	
Santiago Already Retired	0000	9780		30,309.00	
Santiago Retiree Benefits	0000	9780		74,654.00	
RMCO Leadership Retiree Payments	0000	9780		73,912.00	
RMCO Leadership Already Retired	0000	9780		39,506.00	
RMCO #2 Retiree Payments	0000	9780		106,706.00	
RMCO #2 Already Retired	0000	9780		105,917.00	
RMCO #1 Retiree Payments	0000	9780		884,790.00	
RMCO #1 Already Retired	0000	9780		147,305.00	
Retiree Waivers	0000	9780		1,049,994.00	
Retiree Benefits	0000	9780		11,807,808.11	
Santiago RMCO Payments	0000	9780	203,790.00		
Santiago RMCO Already Retired	0000	9780	76,383.00		
Santiago Retiree Benefits	0000	9780	120,728.00		
RMCO Leadership Retiree Payments	0000	9780	73,912.00		
RMCO Leadership Already Retired	0000	9780	68,035.00		
RMCO #2 Retiree Payments	0000	9780	106,706.00		
RMCO #2 Already Retired	0000	9780	214,376.00		
RMCO #1 Retiree Payments	0000	9780	884,790.00		

July 1 Budget (Single Adoption)
 Retiree Benefit Fund
 Expenses by Object

Orange Unified
 Orange County

30 66621 0000000
 Form 71

Description	Resource Codes	Object Codes	2006-07 Estimated Actuals	2007-08 Budget	Percent Difference
RMCO #1 Already Retired	0000	9780	263,714.00		
Retiree Waivers	0000	9780	1,437,994.00		
Retiree Benefits	0000	9780	9,915,035.11		
c) Undesignated Amount		9790	0.00		
d) Unappropriated Amount		9790		0.00	

July 1 Budget (Single Adoption)
 Retiree Benefit Fund
 Expenses by Object

Orange Unified
 Orange County

30 66621 000000
 Form 71

Description	Resource Codes	Object Codes	2006-07 Estimated Actuals	2007-08 Budget	Percent Difference
OTHER LOCAL REVENUE					
Other Local Revenue					
Interest		8660	610,301.00	78,000.00	-87.2%
Net Increase (Decrease) in the Fair Value of Investments		8662	0.00	0.00	0.0%
Fees and Contracts					
In-District Premiums/ Contributions		8674	821,038.00	1,837,000.00	123.7%
Other Local Revenue					
All Other Local Revenue		8699	0.00	0.00	0.0%
TOTAL, OTHER LOCAL REVENUE			1,431,339.00	1,915,000.00	33.8%
TOTAL, REVENUES			1,431,339.00	1,915,000.00	33.8%
SERVICES AND OTHER OPERATING EXPENSES					
Subagreements for Services		5100		0.00	
Professional/Consulting Services and Operating Expenditures		5800	883,852.00	755,772.00	-14.5%
TOTAL, SERVICES AND OTHER OPERATING EXPENSES			883,852.00	755,772.00	-14.5%
TOTAL, EXPENSES			883,852.00	755,772.00	-14.5%

July 1 Budget (Single Adoption)
 Retiree Benefit Fund
 Expenses by Object

Orange Unified
 Orange County

30 66621 000000
 Form 71

Description	Resource Codes	Object Codes	2006-07 Estimated Actuals	2007-08 Budget	Percent Difference
INTERFUND TRANSFERS					
INTERFUND TRANSFERS IN					
Other Authorized Interfund Transfers In		8919	0.00	0.00	0.0%
(a) TOTAL, INTERFUND TRANSFERS IN			0.00	0.00	0.0%
INTERFUND TRANSFERS OUT					
Other Authorized Interfund Transfers Out		7619	0.00	0.00	0.0%
(b) TOTAL, INTERFUND TRANSFERS OUT			0.00	0.00	0.0%
OTHER SOURCES/USES					
SOURCES					
Other Sources					
Transfers from Funds of Lapsed/Reorganized LEAs		8965	0.00	0.00	0.0%
All Other Financing Sources		8979	0.00	0.00	0.0%
(c) TOTAL, SOURCES			0.00	0.00	0.0%
USES					
Transfers from Funds of Lapsed/Reorganized LEAs		7651	0.00	0.00	0.0%
All Other Financing Uses		7699	0.00	0.00	0.0%
(d) TOTAL, USES			0.00	0.00	0.0%
TOTAL, OTHER FINANCING SOURCES/USES (a - b + c - d)			0.00	0.00	0.0%

V

Criteria and Standards

Provide methodology and assumptions used to estimate ADA, enrollment, revenues, expenditures, reserves and fund balance, and multiyear commitments (including cost-of-living adjustments).

Deviations from the standards must be explained and may affect the approval of the budget.

CRITERIA AND STANDARDS

1. CRITERION: Average Daily Attendance

STANDARD: Funded average daily attendance (ADA) has not been overestimated in 1) the first prior year OR in 2) two or more of the previous three years by more than the following percentage levels:

Percentage Level	District ADA		
3.0%	0	to	300
2.0%	301	to	1,000
1.0%	1,001	and	over

District ADA (Form A, Estimated P-2 ADA column, lines 3, 6, and 25):

District's ADA Standard Percentage Level:

4A. Calculating the District's ADA Variances

DATA ENTRY: Enter data in the Revenue Limit ADA, Original Budget column for the First, Second, and Third Prior Years; all other data are extracted or calculated.

Fiscal Year	Revenue Limit (Funded) ADA		ADA Variance Level (If Budget is greater than Actuals, else N/A)	Status
	Original Budget (Form RL, Line 5b)	Estimated/Unaudited Actuals (Form RL, Line 5b)		
Third Prior Year (2004-05)	30,415.18	30,465.47	N/A	Met
Second Prior Year (2005-06)	30,513.51	29,957.98	1.8%	Not Met
First Prior Year (2006-07)	27,419.95	27,163.40	0.9%	Met
Budget Year (2007-08) (Criterion 4A1, Step 2a)	27,023.16			

4B. Comparison of District ADA to the Standard

DATA ENTRY: Enter an explanation if the standard is not met.

4a. STANDARD MET - Funded ADA has not been overestimated by more than the standard percentage level for the first prior year.

Explanation: (required if NOT met)

4b. STANDARD MET - Funded ADA has not been overestimated by more than the standard percentage level for two or more of the previous three years.

Explanation: (required if NOT met)

2. CRITERION: Enrollment

STANDARD: Projected enrollment has not been overestimated in 1) the first prior year OR in 2) two or more of the previous three years by more than the following percentage levels:

Percentage Level	District ADA		
3.0%	0	to	300
2.0%	301	to	1,000
1.0%	1,001	and	over

District ADA (Form A, Estimated P-2 ADA column, lines 3, 6, and 25):

District's Enrollment Standard Percentage Level:

3. Calculating the District's Enrollment Variances

DATA ENTRY: Enter data in the Enrollment, Budget, column for all fiscal years and in the Enrollment, CBEDS Actual, column for the First Prior Year; all other data are extracted or calculated.

Fiscal Year	Budget	Enrollment CBEDS Actual	Enrollment Variance Level (If Budget is greater than Actual, else N/A)	Status
Third Prior Year (2004-05)	29,208	31,351	N/A	Met
Second Prior Year (2005-06)	28,445	30,901	N/A	Met
First Prior Year (2006-07)	27,669	30,063	N/A	Met
Budget Year (2007-08)	27,497			

4. Comparison of District Enrollment to the Standard

DATA ENTRY: Enter an explanation if the standard is not met.

a. STANDARD MET - Enrollment has not been overestimated by more than the standard percentage level for the first prior year.

Explanation:
(required if NOT met)

b. STANDARD MET - Enrollment has not been overestimated by more than the standard percentage level for two or more of the previous three years.

Explanation:
(required if NOT met)

3. CRITERION: ADA to Enrollment Ratio

STANDARD: Projected second period (P-2) average daily attendance (ADA) to enrollment ratio for any of the budget year or two subsequent fiscal years has not increased by more than one half of one percent (0.5%) from the historical average ratio from the three prior fiscal years.

3A. Calculating the District's Historical ADA to Enrollment Ratio Standard

DATA ENTRY: All data are extracted or calculated.

Fiscal Year	P-2 ADA Estimated/Unaudited Actuals (Form A, Lines 3, 6, and 25)	Enrollment CBEDS Actual (Criterion 2, Item 2A)	Historical Ratio of ADA to Enrollment
Third Prior Year (2004-05)	27,944	31,351	89.1%
Second Prior Year (2005-06)	27,468	30,901	88.9%
First Prior Year (2006-07)	26,783	30,063	89.1%
Historical Average Ratio:			89.0%
District's ADA to Enrollment Ratio Standard (historical average ratio plus 0.5%):			89.5%

3B. Calculating the District's Projected Ratio of ADA to Enrollment

DATA ENTRY: If Form MYP exists, Estimated P-2 ADA for the two subsequent years will be extracted; if not, enter Estimated P-2 ADA data in the first column. Enter data in the Enrollment column for the two subsequent years. All other data are extracted or calculated.

Fiscal Year	Estimated P-2 ADA Budget (Form A, Lines 3, 6, and 25) (Form MYP, Line F2)	Enrollment Budget/Projected (Criterion 2, Item 2A)	Ratio of ADA to Enrollment	Status
Budget Year (2007-08)	25,498	27,497	96.4%	Not Met
First Subsequent Year (2008-09)	26,302	27,294	96.4%	Not Met
Second Subsequent Year (2009-10)	25,106	27,091	96.4%	Not Met

3C. Comparison of District ADA to Enrollment Ratio to the Standard

DATA ENTRY: Enter an explanation if the standard is not met.

a. **STANDARD NOT MET** - Projected P-2 ADA to enrollment ratio is above the standard for one or more of the budget or two subsequent fiscal years. Provide reasons why the projected ratio exceeds the district's historical average ratio by more than 0.5%.

Explanation:
(required if NOT met)

The CBEDS enrollment counts include district sponsored charter schools. The 3 year ADA to enrollment average trend for Orange Unified is a 96.354% attendance rate.

4. CRITERION: Revenue Limit

STANDARD: Projected revenue limit for any of the budget year or two subsequent fiscal years has not changed by more than one percent plus or minus the change in population growth and the funded cost-of-living adjustment (COLA) from the prior year.

For basic aid districts, projected revenue limit has not changed by more than the percent increase in property tax revenues from the prior fiscal year.

For districts funded by necessary small school formulas, projected revenue limit has not changed by more than the prior year amount plus the funded cost-of-living adjustment.

1. Calculating the District's Revenue Limit Standard

DATA ENTRY: If Form MYP exists, the 1st and 2nd Subsequent Year columns for Step 1a and Step 2a will be extracted; if not, enter data for the two subsequent years. All other data are extracted or calculated.

Projected Revenue Limit

	Prior Year (2006-07)	Budget Year (2007-08)	1st Subsequent Year (2008-09)	2nd Subsequent Year (2009-10)
Step 1 - Funded COLA				
a. Base Revenue Limit (BRL) per ADA (Form RL, Line 4) (Form MYP, Unrestricted, Line A1a)	5,534.43	5,786.43	6,001.43	6,158.43
b. Deficit Factor (Form RL, Line 16)	1.00000	1.00000	1.00000	1.00000
c. Funded BRL per ADA (Step 1a times Step 1b)	5,534.43	5,786.43	6,001.43	6,158.43
d. Prior Year Funded BRL per ADA		5,534.43	5,786.43	6,001.43
e. Difference (Step 1c minus Step 1d)		252.00	215.00	157.00
f. Percent Change Due to COLA (Step 1e divided by Step 1d)		4.6%	3.7%	2.6%
Step 2 - Change in Population				
a. Revenue Limit (Funded) ADA (Form RL, Line 5b) (Form MYP, Unrestricted, Line A1b)	27,163.40	27,023.16	26,735.66	26,539.62
b. Prior Year Revenue Limit (Funded) ADA		27,163.40	27,023.16	26,735.66
c. Difference (Step 2a minus Step 2b)		(140.24)	(287.50)	(196.04)
d. Percent Change Due to Population (Step 2c divided by Step 2b)		-0.5%	-1.1%	-0.7%
Step 3 - Total Change in Funded COLA and Population (Step 1f plus Step 2d)				
		4.1%	2.6%	1.9%
Revenue Limit Standard (Step 3, plus/minus 1%):		3.1% to 5.1%	1.6% to 3.6%	.9% to 2.9%

2. Alternate Revenue Limit Standard - Basic Aid

DATA ENTRY: If applicable to your district, input data in the 1st and 2nd Subsequent Year columns for projected local property taxes; all other data are extracted or calculated.

Basic Aid District Projected Revenue Limit (Applicable if Form RL, Budget column, line 31, is zero)

	Prior Year (2006-07)	Budget Year (2007-08)	1st Subsequent Year (2008-09)	2nd Subsequent Year (2009-10)
Projected local property taxes (Form RL, Lines 25 thru 27)	112,250,690.00	116,179,319.00	119,660,438.00	123,250,251.00
Basic Aid Standard (Percent change over previous year):		N/A	N/A	N/A

43. Alternate Revenue Limit Standard - Necessary Small School

DATA ENTRY: All data are extracted or calculated.

Necessary Small School District Projected Revenue Limit (Applicable if Form RL, Budget column, line 6, is greater than zero, and line 5b, RL ADA, is zero)

	Budget Year (2007-08)	1st Subsequent Year (2008-09)	2nd Subsequent Year (2009-10)
Necessary Small School Standard (Funded COLA change - Step 1f plus 1%):	N/A	N/A	N/A

43. Calculating the District's Projected Change in Revenue Limit

DATA ENTRY: Enter data in the 1st and 2nd Subsequent Year columns for Revenue Limit; all other data are extracted or calculated.

	Prior Year (2006-07)	Budget Year (2007-08)	1st Subsequent Year (2008-09)	2nd Subsequent Year (2009-10)
Revenue Limit (Fund 01, Objects 8011, 8020-8089)	157,757,759.00	162,224,567.00	166,538,637.00	169,786,879.00
Less: Adjustments for Revenue Limit Coding (Changes Effective 2007-08 (Form RL, Lines 33-37))	1,826,224.00			
Adjusted Revenue Limit	155,931,535.00	162,224,567.00	166,538,637.00	169,786,879.00
District's Projected Change in Revenue Limit:		4.0%	2.7%	2.0%
Revenue Limit Standard:		3.1% to 5.1%	1.6% to 3.6%	.9% to 2.9%
Status:		Met	Met	Met

4C. Comparison of District Revenue Limit to the Standard

DATA ENTRY: Enter an explanation if the standard is not met.

1a. STANDARD MET - Projected change in revenue limit has met the standard for the budget and two subsequent fiscal years.

Explanation:
(required if NOT met)

5. CRITERION: Salaries and Benefits

STANDARD: Projected ratio of total salaries and benefits to total general fund expenditures (excluding transfers out and other financing uses) for any of the budget year or two subsequent fiscal years has not changed by more than two percent from the historical average ratio from the three prior fiscal years.

5A. Calculating the District's Historical Average Ratio of Salaries and Benefits to Total General Fund Expenditures

DATA ENTRY: All data are extracted or calculated.

Fiscal Year	Estimated/Unaudited Actuals		Ratio of Salaries and Benefits to Total Expenditures
	Salaries and Benefits (Form 01, Objects 1000-3999)	Total Expenditures (Form 01, Objects 1000-7499)	
Third Prior Year (2004-05)	186,929,479.42	223,337,811.48	83.7%
Second Prior Year (2005-06)	179,543,729.37	219,283,200.11	81.9%
First Prior Year (2006-07)	198,952,807.00	243,272,443.00	81.8%
Historical Average Ratio:			82.5%
District's Salaries and Benefits Standard (historical average ratio plus/minus 2%):			80.5% to 84.5%

5B. Calculating the District's Projected Ratio of Salaries and Benefits to Total General Fund Expenditures

DATA ENTRY: If Form MYP exists, Salaries and Benefits, and Total Expenditures data for the 1st and 2nd Subsequent Years will be extracted; if not, enter data for the two subsequent years. All other data are extracted or calculated.

Fiscal Year	Budget		Ratio of Salaries and Benefits to Total Expenditures	Status
	Salaries and Benefits (Form MYP, Lines B1-B3)	Total Expenditures (Form MYP, Lines B1-B8, B10)		
Budget Year (2007-08)	203,093,189.00	244,283,152.00	83.1%	Met
First Subsequent Year (2008-09)	205,684,431.00	240,171,266.00	85.6%	Not Met
Second Subsequent Year (2009-10)	208,743,089.00	243,895,499.00	85.6%	Not Met

5C. Comparison of District Salaries and Benefits Ratio to the Standard

DATA ENTRY: Enter an explanation if the standard is not met.

- 1a. STANDARD NOT MET - Projected ratio(s) of salary and benefit costs to total expenditures are outside the standard in one or more of the budget or two subsequent fiscal years. Provide reasons why the projection(s) exceed the standard, a description of the methods and assumptions used in projecting salaries and benefits, and what changes, if any, will be made to bring the projected salary and benefit costs within the standard.

Explanation:
(required if NOT met)

The budget and subsequent years total expenditures are \$8 million lower than the 3 prior years total expenditures due to In-lieu taxes paid to charter schools being reclassified to revenue limit transfers in the budget years.

6. CRITERION: Other Revenues and Expenditures

STANDARD: Projected operating revenues and expenditures by major object category for any of the budget year or two subsequent fiscal years have not changed by more than five percent from the prior year amount.

District's Other Revenues and Expenditures Percentage Range: -5.0% to +5.0%

6A. Calculating the District's Change by Major Object Category

DATA ENTRY: If Form MYP exists, the 1st and 2nd Subsequent Year data for each revenue and expenditure section will be extracted; if not, enter data for the two subsequent years. All other data are extracted or calculated.

Object Range / Fiscal Year	Amount	Percent Change Over Previous Year	Status
Federal Revenue (Fund 01, Objects 8100-8299) (Form MYP, Line A2)			
First Prior Year (2006-07)	14,966,407.00		
Budget Year (2007-08)	13,130,286.00	-12.3%	Not Met
1st Subsequent Year (2008-09)	12,949,867.00	-1.4%	Met
2nd Subsequent Year (2009-10)	12,949,867.00	0.0%	Met
Other State Revenue (Fund 01, Objects 8300-8599) (Form MYP, Line A3)			
First Prior Year (2006-07)	57,551,962.00		
Adjustments: First Prior Year Adjustment (Criterion 4B)	1,826,224.00		
Adjusted First Prior Year (2006-07)	59,378,186.00		
Budget Year (2007-08)	52,249,605.00	-12.0%	Not Met
1st Subsequent Year (2008-09)	52,825,856.00	1.1%	Met
2nd Subsequent Year (2009-10)	53,455,732.00	1.2%	Met
Other Local Revenue (Fund 01, Objects 8600-8799) (Form MYP, Line A4)			
First Prior Year (2006-07)	14,686,922.00		
Budget Year (2007-08)	8,898,082.00	-39.4%	Not Met
1st Subsequent Year (2008-09)	8,635,553.00	-3.0%	Met
2nd Subsequent Year (2009-10)	8,643,451.00	0.1%	Met
Books and Supplies (Fund 01, Objects 4000-4999) (Form MYP, Line B4)			
First Prior Year (2006-07)	11,489,165.00		
Budget Year (2007-08)	15,300,765.00	33.2%	Not Met
1st Subsequent Year (2008-09)	8,794,100.00	-42.5%	Not Met
2nd Subsequent Year (2009-10)	8,978,047.00	2.1%	Met
Services and Other Expenditures (Fund 01, Objects 5000-5999) (Form MYP, Line B5)			
First Prior Year (2006-07)	21,900,597.00		
Budget Year (2007-08)	22,995,113.00	5.0%	Met
1st Subsequent Year (2008-09)	22,998,761.00	0.0%	Met
2nd Subsequent Year (2009-10)	23,329,013.00	1.4%	Met

6B. Comparison of District Other Revenues and Expenditures to the Standard

DATA ENTRY: Enter an explanation if the standard is not met.

- 1a. **STANDARD NOT MET** - One or more projected operating revenue or expenditure object categories have changed by more than the standard in one or more of the budget or two subsequent fiscal years. Provide reasons for the projected change, descriptions of the methods and assumptions used in the projections, and what changes, if any, will be made to bring the projected revenues and expenditures within the standard.

Explanation:
(required if NOT met)

FY07 Revenues include deferred revenues and significant one-time state programs not included in the budget years. FY07 Other local revenues include the locally funded charter school In-lieu Property Tax revenue which has been reclassified to a revenue limit transfer in the budget years. FY07 and FY08 Books/Supplies include balances budgeted for unspent prior year school site/categorical program allocations. FY09 and FY10 assume those funds will be expended.

7. CRITERION: Facilities Maintenance

STANDARD: Confirm that the annual contribution for facilities maintenance funding is not less than the amounts required pursuant to Education Code (EC) Section 17584 (Deferred Maintenance) and EC Section 17070.75 (Ongoing and Major Maintenance/Restricted Maintenance Account).

7A. Determining the District's Compliance with the Contribution Requirement for EC Section 17584 - Deferred Maintenance

DATA ENTRY: Enter data in the Contributed column for Deferred Maintenance Contribution; all other data are extracted or calculated. If standard is not met, enter an X in the appropriate box and enter an explanation, if applicable.

Deferred Maintenance Contribution

	Required ¹	Contributed ²	Status
Deferred Maintenance	1,146,791	1,146,791	Met

¹ Represents the district's prior year deferred maintenance "maximum match" amount released by the California Department of Education.

² Include amounts budgeted per EC Section 17584(b) and unmatched carryover per California Code of Regulations, Title 2, Section 1866.4.4.

If standard is not met, enter an X in the box that best describes why the required contribution was not made:

- Not applicable (district does not participate in the deferred maintenance program)
- Other (explanation must be provided)

Explanation:
(required if NOT met
and Other is marked)

7B. Determining the District's Compliance with the Contribution Requirement for EC Section 17070.75 - Ongoing and Major Maintenance/Restricted Maintenance Account (OMMA/RMA)

DATA ENTRY: Click the appropriate Yes or No button for special education local plan area (SELPA) administrative units (AUs); all other data are extracted or calculated. If standard is not met, enter an X in the appropriate box and enter an explanation, if applicable.

- 1 a. For districts that are the AU of a SELPA, do you choose to exclude revenue that are passed through to participating members of the SELPA from the OMMA/RMA required minimum contribution calculation? No
- b. Pass-through revenues and apportionments that may be excluded from the OMMA/RMA calculation per EC Section 17070.75(b)(2)(C) (Fund 01, objects 7211-7223 with resources 3300-3499 and 6500-6540)

Ongoing and Major Maintenance/Restricted Maintenance Account

a. Budgeted Expenditures, Transfers Out, and Uses (Form 01, objects 1000-7999)	245,498,752.00			
b. Less: Pass-through Revenues and Apportionments (Line 1b, if line 1a is Yes)		3% Required Minimum Contribution (Line 2c times 3%)	Budgeted Contribution ² to the Ongoing and Major Maintenance Account	Status
c. Net Budgeted Expenditures, Transfers Out, and Uses	245,498,752.00	7,364,962.56	7,365,085.00	Met

² Fund 01, Resource 8150, objects 8900-8999

If standard is not met, enter an X in the box that best describes why the minimum required contribution was not made:

- Not applicable (district does not participate in the Leroy F. Green School Facilities Act of 1998)
- Exempt (due to district's small size [EC Section 17070.75 (b)(2)(D)])
- Other (explanation must be provided)

Explanation:
(required if NOT met
and Other is marked)

8. CRITERION: Deficit Spending

STANDARD: Deficit spending (revenues plus transfers in and other financing sources, less expenditures, transfers out and other financing uses) resulting in a negative amount, as a percentage of total expenditures, transfers out and other financing uses, has not exceeded the following absolute percentage levels in two out of three prior fiscal years:

Percentage Level ¹	District ADA		
1.7%	0	to	300
1.3%	301	to	1,000
1.0%	1,001	to	30,000
0.7%	30,001	to	400,000
0.3%	400,001	and	over

¹ Percentage levels equate to a rate of deficit spending which would eliminate recommended reserves for economic uncertainties over a three year period.

District ADA (Form A, Estimated P-2 ADA column, lines 3, 6, and 25):

District's Deficit Spending Standard Percentage Level:

A. Calculating the District's Deficit Spending Percentages

DATA ENTRY: All data are extracted or calculated.

Fiscal Year	Net Change in Fund Balance (Form 01, Section E)	Total Expenditures, Transfers Out, and Uses (Fund 01, Objects 1000-7999)	Deficit Spending Level (If Net Change in Fund Balance is negative, else N/A)	Status
Third Prior Year (2004-05)	4,228,748.26	224,706,843.48	N/A	Met
Second Prior Year (2005-06)	1,988,956.50	221,432,654.11	N/A	Met
First Prior Year (2006-07)	3,423,548.00	244,461,206.00	N/A	Met
Budget Year (2007-08) (Information only)	(10,197,650.00)	245,498,752.00		

B. Comparison of District Deficit Spending to the Standard

DATA ENTRY: Enter an explanation if the standard is not met.

ia. STANDARD MET - Deficit spending, if any, has not exceeded the standard percentage level in two or more of the three prior years.

Explanation:
(required if NOT met)

9. CRITERION: Fund Balance

STANDARD: Budgeted beginning unrestricted general fund balance has not been overestimated for two out of three prior fiscal years by the following percentage levels:

Percentage Level ¹	District ADA
1.7%	0 to 300
1.3%	301 to 1,000
1.0%	1,001 to 30,000
0.7%	30,001 to 400,000
0.3%	400,001 and over

¹ Percentage levels equate to a rate of deficit spending which would eliminate recommended reserves for economic uncertainties over a three year period.

District ADA (Form A, Estimated P-2 ADA column, lines 3, 6, and 25):

District's Fund Balance Standard Percentage Level:

Calculating the District's Unrestricted General Fund Beginning Balance Percentages

DATA ENTRY: Enter data in the Original Budget column for the First, Second, and Third Prior Years; all other data are extracted or calculated.

Fiscal Year	Unrestricted General Fund Beginning Balance ² (Form 01, Line F1e, Unrestricted Column)		Beginning Fund Balance Variance Level (If overestimated, else N/A)	Status
	Original Budget	Estimated/Unaudited Actuals		
Third Prior Year (2004-05)	12,132,764.35	13,403,298.97	N/A	Met
Second Prior Year (2005-06)	17,792,785.97	16,978,640.96	4.6%	Not Met
First Prior Year (2006-07)	15,584,832.96	19,352,890.65	N/A	Met

² Adjusted beginning balance, including audit adjustments and other restatements (objects 9791-9795)

9B. Comparison of District Unrestricted Beginning Fund Balance to the Standard

DATA ENTRY: Enter an explanation if the standard is not met.

1a. **STANDARD MET** - Unrestricted general fund beginning fund balance has not been overestimated by more than the standard percentage level for two or more of the previous three years.

Explanation:
(required if NOT met)

In FY06 collective bargaining agreements totalling \$2,118,000 were reached between the original budget and unaudited actual reporting periods. The amount for negotiations was designated as a component of the estimated actuals ending balance, but were included in the unaudited actual expenditures, decreasing the actual beginning balance.

10. CRITERION: Reserves

STANDARD: Available reserves for any of the budget year or two subsequent fiscal years are not less than the following percentages or amounts as applied to total expenditures, transfers out¹ and other financing uses:

Percentage Level	District ADA		
5% or \$53,000 ² (greater of)	0	to	300
4% or \$53,000 ² (greater of)	301	to	1,000
3%	1,001	to	30,000
2%	30,001	to	400,000
1%	400,001	and	over

¹ An administrative unit (AU) of a special education local plan area (SELPA) may exclude the distribution of revenues to its participating members.

² Dollar thresholds to be adjusted annually by the prior year statutory cost-of-living adjustment (Education Code Section 42238) and then rounded to the nearest thousand.

	Budget Year (2007-08)	1st Subsequent Year (2008-09)	2nd Subsequent Year (2009-10)
District Estimated P-2 ADA (Criterion 3, Item 3B):	26,498	26,302	26,106
District's Reserve Standard Percentage Level:	3%	3%	3%

A. Calculating the District's Special Education Pass-through Exclusions (only for districts that serve as the AU of a SELPA)

DATA ENTRY: For SELPA AUs, if Form MYP exists, all data will be extracted including the Yes/No button selection. If not, click the appropriate Yes or No button for item 1 and, if Yes, enter data for item 2a and for the two subsequent years in item 2b; Budget Year data are extracted.

For districts that serve as the AU of a SELPA (Form MYP, Lines F1a, F1b, and F2):

- Do you choose to exclude from the reserve calculation the pass-through funds distributed to SELPA members?
- If you are the SELPA AU and are excluding special education pass-through funds:
 - Enter the name(s) of the SELPA(s):

	Budget Year (2007-08)	1st Subsequent Year (2008-09)	2nd Subsequent Year (2009-10)
b. Amount to be excluded from the reserve calculation for special education pass-through funds (Fund 01, resources 3300-3499 and 6500-6540, objects 7211-7213 and 7221-7223):	507,878.00		

10B. Calculating the District's Reserve Standard

DATA ENTRY: If Form MYP exists, 1st and 2nd Subsequent Year data for lines 1 and 2 will be extracted; if not, enter data for the two subsequent years. All other data are extracted or calculated.

	Budget Year (2007-08)	1st Subsequent Year (2008-09)	2nd Subsequent Year (2009-10)
1. Total Expenditures, Transfers Out, and Uses (Criterion 8A) (Form MYP, Line B11)	245,498,752.00	241,459,804.00	245,261,349.00
2. Less: Special Education Pass-through (Line A2b, if line A1 is Yes)			
3. Net Expenditures, Transfers Out, and Uses (Line B1 minus line B2)	245,498,752.00	241,459,804.00	245,261,349.00
4. Reserve Standard Percentage Level	3%	3%	3%
5. Reserve Standard - by Percent (Line B3 times line B4)	7,364,962.56	7,243,794.12	7,357,840.47
6. Reserve Standard - by Amount (\$53,000 for districts with 0 to 1,000 ADA, else 0)	0.00	0.00	0.00
7. District's Reserve Standard (Greater of line B5 or line B6)	7,364,962.56	7,243,794.12	7,357,840.47

C. Calculating the District's Budgeted Reserve Amount

DATA ENTRY: If Form MYP exists, 1st and 2nd Subsequent Year data for lines 1 through 5 will be extracted; if not, enter data for the two subsequent years.
" " other data are extracted or calculated.

	Budget Year	1st Subsequent Year	2nd Subsequent Year
	(2007-08)	(2008-09)	(2009-10)
Designated Reserve Amounts (Unrestricted, resources 0000-1999 except 3):			
1. General Fund - Designated for Economic Uncertainties (Fund 01, Object 9770) (Form MYP, Line E1a)	7,364,963.00	7,243,794.00	7,357,840.00
2. General Fund - Unappropriated Amount (Fund 01, Object 9790) (Form MYP, Line E1b)	6,847,435.65	5,181,870.36	3,234,093.36
3. General Fund - Restricted Ending Fund Balance, if negative (Form 01, Line F2) (Form MYP, Line E1c)	0.00	0.00	0.00
4. Special Reserve Fund - Designated for Economic Uncertainties (Fund 17, Object 9770) (Form MYP, Line E2a)	0.00	0.00	0.00
5. Special Reserve Fund - Unappropriated Amount (Fund 17, Object 9790) (Form MYP, Line E2b)	0.00	0.00	0.00
6. District's Budgeted Reserves (Lines C1 thru C5)	14,212,398.65	12,425,664.36	10,591,933.36
District's Reserve Standard (Section 10B, Line B7):	7,364,962.56	7,243,794.12	7,357,840.47
Status:	Met	Met	Met

D. Comparison of District Reserves to the Standard

DATA ENTRY: Enter an explanation if the standard is not met.

1a. STANDARD MET - Projected available reserves have met the standard for the budget and two subsequent fiscal years.

Explanation:
(required if NOT met)

SUPPLEMENTAL INFORMATION

DATA ENTRY: Click the appropriate Yes or No button for items S1 through S4. Enter an explanation for each Yes answer.

S1. Contingent Liabilities

1a. Does your district have any known or contingent liabilities (e.g., financial or program audits, litigation, state compliance reviews) that may impact the budget?

No

1b. If Yes, identify the liabilities and how they may impact the budget:

S2. Use of One-time Revenues for Ongoing Expenditures

1a. Does your district have ongoing general fund expenditures in the budget in excess of one percent of the total general fund expenditures that are funded with one-time resources?

No

1b. If Yes, identify the expenditures and explain how the one-time resources will be replaced to continue funding the ongoing expenditures in the following years:

S3. Use of Ongoing Revenues for One-time Expenditures

1a. Does your district have large non-recurring general fund expenditures that are funded with ongoing general fund revenues?

No

1b. If Yes, identify the expenditures:

S4. Contingent Revenues

1a. Does your district have projected revenues for any of the budget year or two subsequent fiscal years contingent on reauthorization by the local government, special legislation, or other definitive act (e.g., parcel taxes, forest reserves)?

No

1b. If Yes, identify any of these revenues that are dedicated for ongoing expenses and explain how the revenues will be replaced or expenditures reduced:

35. Contributions

Identify projected contributions from the unrestricted general fund to restricted programs in the general fund for any of the budget year or two subsequent fiscal years. Provide an explanation if contributions have changed by more than ten percent from prior year amounts. Explanation should include whether contributions are ongoing or one-time in nature.

Identify projected transfers to or from the general fund to cover operating deficits in either the general fund or any other fund for any of the budget year or two subsequent fiscal years. Provide an explanation if transfers have changed by more than ten percent from prior year amounts. Explanation should include whether transfers are ongoing or one-time in nature.

Estimate the impact of any capital projects on the general fund operational budget.

District's Contributions and Transfers Percentage Range:

35A. Identification of the District's Projected Contributions, Transfers, and Capital Projects that may Impact the General Fund

DATA ENTRY: Enter data in the Projection column for contributions, transfers in, and transfers out for all fiscal years, except the First Prior Year and Budget Year for Contributions, which will be extracted, and click the appropriate button for item 1d; all other data are extracted or calculated.

Description / Fiscal Year	Projection	Percent Change	Status
1a. Contributions, Unrestricted General Fund (Fund 01, Resources 0000-1999, Object 8980)			
First Prior Year (2006-07)	(18,149,782.00)		
Budget Year (2007-08)	(20,451,741.00)	12.7%	Not Met
First Subsequent Year (2008-09)	(21,431,606.00)	4.8%	Met
2nd Subsequent Year (2009-10)	(22,325,813.00)	4.2%	Met
1b. Transfers In, General Fund *			
First Prior Year (2006-07)	0.00		
Budget Year (2007-08)	0.00	0.0%	Met
First Subsequent Year (2008-09)	0.00	0.0%	Met
2nd Subsequent Year (2009-10)	0.00	0.0%	Met
1c. Transfers Out, General Fund *			
First Prior Year (2006-07)	1,188,763.00		
Budget Year (2007-08)	1,215,600.00	2.3%	Met
First Subsequent Year (2008-09)	1,288,538.00	6.0%	Met
2nd Subsequent Year (2009-10)	1,365,850.00	6.0%	Met

1d. Impact of Capital Projects

Do you have any capital projects that may impact the general fund operational budget?

* Include transfers used to cover operating deficits in either the general fund or any other fund.

35B. Status of the District's Projected Contributions, Transfers, and Capital Projects

DATA ENTRY: Enter an explanation if Not Met for items 1a-1c or if Yes for item 1d.

1a. NOT MET - The projected contributions from the unrestricted general fund to restricted general fund programs have changed by more than ten percent for one or more of the budget or subsequent two fiscal years. Identify restricted programs and amount of contribution for each program and whether contributions are ongoing or one-time in nature. Explain the district's plan, with timeframes, for reducing or eliminating the contribution.

Explanation:
(required if NOT met)

Special Education expenditures were decreased to reflect current year expenditure estimates. In addition, autism and occupational therapy services, among others provided by outside agencies are currently being provided by staff.

1b. MET - Projected transfers in have not changed by more than ten percent for the budget and two subsequent fiscal years.

Explanation:
(required if NOT met)

1c. MET - Projected transfers out have not changed by more than ten percent for the budget and two subsequent fiscal years.

Explanation:
(required if NOT met)

1d. NO - There are no capital projects that may impact the general fund operational budget.

Project Information:
(required if YES)

56. Long-term Commitments

Identify all existing multiyear commitments and their annual required payment, and all new multiyear commitments and their annual fiscal impact. Also identify continuing and new multiyear debt agreements and new programs.

Compare the increase in long-term commitments to the projected increase in ongoing revenues, and explain how these commitments will be funded in future years.

56A. Identification of the District's Long-term Commitments

DATA ENTRY: Click the appropriate button in item 1 and enter data in all columns of item 2 for applicable long-term commitments; there are no extractions in this section.

1. Does your district have long-term (multiyear) commitments?
(If No, skip item 2)

2. List all new and existing multiyear commitments and required annual debt service amounts.

Type of Commitment SACS Codes Used	# of Years Remaining	Principal Balance	Prior Year	Budget Year	1st Subsequent Year	2nd Subsequent Year
		as of July 1, 2007	(2006-07) Annual Payment (P & I)	(2007-08) Annual Payment (P & I)	(2008-09) Annual Payment (P & I)	(2009-10) Annual Payment (P & I)
Capital Leases	20	5,868,216	373,062	575,630	643,152	425,020
Fund/Resource/Object:						
Certificates of Participation	2	247,162	251,952	253,341		
Fund/Resource/Object:						
Other Postemployment Benefits	72	150,214,204	6,109,735	6,330,674	6,848,319	7,276,030
Fund/Resource/Object:						
Prop Early Retirement Program						
Fund/Resource/Object:						
State School Building Loans						
Fund/Resource/Object:						
Compensated Absences		2,672,785				
Fund/Resource/Object:		No expense incurred				
Other Long-term Commitments:						
Commitment Type:						
Fund/Resource/Object:						
Total Annual Payments:			6,734,749	7,159,645	7,491,471	7,701,050
Percent Change Over Previous Year:				6.3%	4.6%	2.8%

56B. Calculating the District's Change in Revenues

DATA ENTRY: All data are extracted or calculated.

	Prior Year (2006-07)	Budget Year (2007-08)	1st Subsequent Year (2008-09)	2nd Subsequent Year (2009-10)
Revenue Limit (Criterion 4B, Adjusted Revenue Limit) (Fund 01, Objects 0011, 8020-8089)	155,931,535.00	162,224,567.00	166,538,637.00	169,786,879.00
Percent Change Over Previous Year:		4.0%	2.7%	2.0%
Status:		Not Met	Not Met	Not Met

56C. Comparison of the District's Long-term Commitments to Revenues

DATA ENTRY: Enter an explanation if Not Met.

1a. NOT MET - The percent change in annual payments for long-term commitments exceeds the change in revenues for any of the budget or two subsequent fiscal years. Explain how these long-term commitments will be funded in future years. For funding sources that will expire prior to the end of the commitment period, or are funded with one-time sources, provide an explanation for how those funds will be replaced to continue annual debt service commitments.

Explanation:
(required if NOT met)

On June 7, 2007 the Board of Education directed staff to develop a plan to meet the district's postemployment benefit obligations, including investigating issuance of other postemployment benefits bonds.

57. Unfunded Liabilities

Estimate the unfunded liability for postemployment benefits based on an actuarial study, if required, or other method; and identify the estimated or required annual contribution and how the costs are accounted for (pay-as-you-go, amortized over a specific period, etc.)

Estimate the unfunded liability for any other self-insured benefits programs (e.g. workers' compensation), based on an actuarial study, if required, or other method; and identify the estimated or required annual contribution and how the costs are accounted for (pay-as-you-go, amortized over a specific period, etc.).

57A. Identification of the District's Estimated Unfunded Liability for Postemployment Benefits Other than Pensions (OPEB)

DATA ENTRY: Click the appropriate button in item 1 and enter data in all other applicable items; there are no extractions in this section.

1. Does your district provide postemployment benefits other than pensions (OPEB)? (If No, skip items 2-6)

2. For the district's OPEB:
a. Are they lifetime benefits?

b. Do benefits continue past age 65?

c. Describe any other characteristics of the district's OPEB program including eligibility information:

Post employment benefits from age 55 to 65 are offered to: Certificated employees after 15 years of service to the district. Management/Supervisor/Confidential employees after 5 years of service; Classified employees are not eligible for this benefit. Eligibility for lifetime benefits were eliminated for employees hired subsequent to June 30, 1992.

3. Are OPEB funded on a pay-as-you-go, actuarial cost, or other method?

4. If Pay-as-you-go, disclose the following information:

	Budget Year (2007-08)	1st Subsequent Year (2008-09)	2nd Subsequent Year (2009-10)
Number of retirees receiving OPEB	1,037	1,037	1,037
Total annual cost	6,370,674	6,848,319	7,276,030
Percent of total annual cost paid by retiree	17%	17%	17%
Percent of total annual cost paid by employer (100% minus retiree %)	83%	83%	83%

5. Total liability for OPEB

a. Is total liability based on an estimate or actuarial study?

b. If based on an actuarial study, indicate the date of the study.

6. Amount of total OPEB liability that is unfunded

57B. Identification of the District's Unfunded Liability for Other Self-insured Benefits

DATA ENTRY: Click the appropriate button in item 1 and enter data in all other applicable items; there are no extractions in this section.

1. Does your district provide other self-insured benefits (e.g., workers' compensation)? (If No, skip items 2-6)

2. Describe any other self-insured benefit programs operated by the district. Include details on whether the programs are lifetime or limited, and eligibility information:

Orange Unified School District began its self-insured workers' compensation program on July 1, 1981. From March 1, 1997 through June 30, 2003, the District purchased first dollar insurance. The District resumed its self insurance program on July 1, 2003. Its current self-insured retention is \$350,000 and excess coverage is provided by Gray Insurance for the \$350,000 to \$500,000 layer with a corridor deductible of \$225,000 and Insurance Corp of Hanover provides excess coverage for the \$500,000 to \$25 million layer.

3. Are other self-insured benefit programs funded on a pay-as-you-go, actuarial cost, or other method?

4. If Pay-as-you-go, what is the total annual cost?

	Budget Year (2007-08)	1st Subsequent Year (2008-09)	2nd Subsequent Year (2009-10)

5. Total liability for providing the other self-insured benefits

a. Is total liability based on an estimate or actuarial study?

b. If based on an actuarial study, indicate the date of the study.

6. Amount of total liability that is unfunded

58. Status of Labor Agreements

Analyze the status of employee labor agreements. Identify new labor agreements, as well as new commitments provided as part of previously ratified multiyear agreements; include all contracts, including all administrator contracts (and including all compensation). For new agreements, indicate the date of the required board meeting. Compare the increase in new commitments to the projected increase in ongoing revenues, and explain how these commitments will be funded in future years.

If salary and benefit negotiations are not finalized at budget adoption, upon settlement with certificated or classified staff:

The school district must determine the cost of the settlement, including salaries, benefits, and any other agreements that change costs, and provide the county office of education (COE) with an analysis of the cost of the settlement and its impact on the operating budget.

The county superintendent shall review the analysis relative to the criteria and standards, and may provide written comments to the president of the district governing board and superintendent.

58A. Cost Analysis of District's Labor Agreements - Certificated (Non-management) Employees

DATA ENTRY: Enter all applicable data items; there are no extractions in this section.

	Prior Year (2nd Interim) (2006-07)	Budget Year (2007-08)	1st Subsequent Year (2008-09)	2nd Subsequent Year (2009-10)
Number of certificated (non-management) full-time-equivalent (FTE) positions	1,396.0	1,382.0	1,376.0	1,376.0

Certificated (Non-management) Salary and Benefit Negotiations

No

1. Are salary and benefit negotiations settled for the budget year?

If Yes, and the corresponding public disclosure documents have been filed with the COE, complete questions 2 and 3.

If Yes, and the corresponding public disclosure documents have not been filed with the COE, complete questions 2-5.

If No, complete questions 6 and 7.

Negotiations Settled

1a. Per Government Code Section 3547.5(a), date of public disclosure board meeting:

2b. Per Government Code Section 3547.5(b), was the agreement certified by the district superintendent and chief business official?

If Yes, date of Superintendent and CBO certification:

3. Per Government Code Section 3547.5(c), was a budget revision adopted to meet the costs of the agreement?

If Yes, date of budget revision board adoption:

4. Period covered by the agreement:

Begin Date:

End Date:

5. Salary settlement:

Budget Year
(2007-08)

1st Subsequent Year
(2008-09)

2nd Subsequent Year
(2009-10)

Is the cost of salary settlement included in the budget and multiyear projections (MYPs)?

--	--	--

One Year Agreement

Total cost of salary settlement

--	--	--

% change in salary schedule from prior year
or

--

Multiyear Agreement

Total cost of salary settlement

--	--	--

% change in salary schedule from prior year
(may enter text, such as "Reopener")

--	--	--

Identify the source of funding that will be used to support multiyear salary commitments:

Negotiations Not Settled

6. Cost of a one percent increase in salary and statutory benefits 1,013,000

	Budget Year (2007-08)	1st Subsequent Year (2008-09)	2nd Subsequent Year (2009-10)
7. Amount included for any tentative salary increases	0	0	0

Certificated (Non-management) Health and Welfare (H&W) Benefits

1. Are costs of H&W benefit changes included in the budget and MYPs?
2. Total cost of H&W benefits
3. Percent of H&W cost paid by employer
4. Percent projected change in H&W cost over prior year

	Budget Year (2007-08)	1st Subsequent Year (2008-09)	2nd Subsequent Year (2009-10)
	No	No	No
	9,527,218	9,816,218	9,816,216
	83%	83%	83%
	5.0%	3.0%	3.0%

Certificated (Non-management) Prior Year Settlements

- Are any new costs from prior year settlements included in the budget?
If Yes, amount of new costs included in the budget and MYPs
If Yes, explain the nature of the new costs:

	Budget Year (2007-08)	1st Subsequent Year (2008-09)	2nd Subsequent Year (2009-10)
	Yes		
	498,236	289,000	289,000

The new costs are due to increases in the Kaiser premium which is below the cap amount.

Certificated (Non-management) Step and Column Adjustments

1. Are step & column adjustments included in the budget and MYPs?
2. Cost of step & column adjustments
3. Percent change in step & column over prior year

	Budget Year (2007-08)	1st Subsequent Year (2008-09)	2nd Subsequent Year (2009-10)
	Yes	Yes	Yes
	1,722,100	1,751,375	1,781,149
	1.7%	1.7%	1.7%

Certificated (Non-management) Attrition (layoffs and retirements)

1. Are savings from attrition included in the budget and MYPs?
2. Are additional H&W benefits for those laid-off or retired employees included in the budget and MYPs?

	Budget Year (2007-08)	1st Subsequent Year (2008-09)	2nd Subsequent Year (2009-10)
	Yes	Yes	Yes
	No	No	No

Certificated (Non-management) - Other

Other significant contract changes and the cost impact of each change (i.e., class size, hours of employment, leave of absence, bonuses, etc.):

None

9B. Cost Analysis of District's Labor Agreements - Classified (Non-management) Employees

DATA ENTRY: Enter all applicable data items; there are no extractions in this section.

	Prior Year (2nd Interim) (2006-07)	Budget Year (2007-08)	1st Subsequent Year (2008-09)	2nd Subsequent Year (2009-10)
Number of classified (non-management) positions	873.0	873.0	873.0	873.0

Classified (Non-management) Salary and Benefit Negotiations

No

1. Are salary and benefit negotiations settled for the budget year?
If Yes, and the corresponding public disclosure documents have been filed with the COE, complete questions 2 and 3.

If Yes, and the corresponding public disclosure documents have not been filed with the COE, complete questions 2-5.

If No, complete questions 6 and 7.

Negotiations Settled

2a. Per Government Code Section 3547.5(a), date of public disclosure board meeting:

2b. Per Government Code Section 3547.5(b), was the agreement certified by the district superintendent and chief business official?
If Yes, date of Superintendent and CBO certification:

3. Per Government Code Section 3547.5(c), was a budget revision adopted to meet the costs of the agreement?
If Yes, date of budget revision board adoption:

4. Period covered by the agreement: Begin Date: End Date:

5. Salary settlement:

	Budget Year (2007-08)	1st Subsequent Year (2008-09)	2nd Subsequent Year (2009-10)
Is the cost of salary settlement included in the budget and multiyear projections (MYPs)?	<input type="text"/>	<input type="text"/>	<input type="text"/>

	Budget Year (2007-08)	1st Subsequent Year (2008-09)	2nd Subsequent Year (2009-10)
One Year Agreement			
Total cost of salary settlement	<input type="text"/>	<input type="text"/>	<input type="text"/>
% change in salary schedule from prior year	<input type="text"/>	<input type="text"/>	<input type="text"/>
or			
Multiyear Agreement			
Total cost of salary settlement	<input type="text"/>	<input type="text"/>	<input type="text"/>
% change in salary schedule from prior year (may enter text, such as "Reopener")	<input type="text"/>	<input type="text"/>	<input type="text"/>

Identify the source of funding that will be used to support multiyear salary commitments:

Negotiations Not Settled

6. Cost of a one percent increase in salary and statutory benefits

7. Amount included for any tentative salary increases

	Budget Year (2007-08)	1st Subsequent Year (2008-09)	2nd Subsequent Year (2009-10)
	0	0	0

Classified (Non-management) Health and Welfare (H&W) Benefits

1. Are costs of H&W benefit changes included in the budget and MYPs?
2. Total cost of H&W benefits
3. Percent of H&W cost paid by employer
4. Percent projected change in H&W cost over prior year

Budget Year (2007-08)	1st Subsequent Year (2008-09)	2nd Subsequent Year (2009-10)
No	No	No
5,957,925	6,138,752	6,319,579
83.5	84%	84%
5.5%	4.8%	4.8%

Classified (Non-management) Prior Year Settlements

- Are any new costs from prior year settlements included in the budget?
If Yes, amount of new costs included in the budget and MYPs
If Yes, explain the nature of the new costs:

Budget Year (2007-08)	1st Subsequent Year (2008-09)	2nd Subsequent Year (2009-10)
No		
311,745	180,827	180,827

The new costs are due to increases in the Kaiser premium which is below the cap.

Classified (Non-management) Step and Column Adjustments

1. Are step & column adjustments included in the budget and MYPs?
2. Cost of step & column adjustments
3. Percent change in step & column over prior year

Budget Year (2007-08)	1st Subsequent Year (2008-09)	2nd Subsequent Year (2009-10)
Yes	Yes	Yes
714,000	726,000	738,000
1.7%	1.7%	1.7%

Classified (Non-management) Attrition (layoffs and retirements)

1. Are savings from attrition included in the budget and MYPs?
2. Are additional H&W benefits for those laid-off or retired employees included in the budget and MYPs?

Budget Year (2007-08)	1st Subsequent Year (2008-09)	2nd Subsequent Year (2009-10)
Yes	Yes	Yes
No	No	No

Classified (Non-management) - Other

Other significant contract changes and the cost impact of each change (i.e., hours of employment, leave of absence, bonuses, etc.):

None

S8C. Cost Analysis of District's Labor Agreements - Management/Supervisor/Confidential Employees

DATA ENTRY: Enter all applicable data items; there are no extractions in this section.

	Prior Year (2nd Interim) (2006-07)	Budget Year (2007-08)	1st Subsequent Year (2008-09)	2nd Subsequent Year (2009-10)
Number of management, supervisor, and Confidential FTE positions	145.0	145.0	145.0	145.0

Management/Supervisor/Confidential Salary and Benefit Negotiations

1. Are salary and benefit negotiations settled for the budget year?

No

If Yes, complete question 2.

If No, complete questions 3 and 4.

If n/a, skip the remainder of Section S8C.

Negotiations Settled

2. Salary settlement:

	Budget Year (2007-08)	1st Subsequent Year (2008-09)	2nd Subsequent Year (2009-10)
Is the cost of salary settlement included in the budget and multiyear projections (MYPs)?			
Total cost of salary settlement			
% change in salary schedule from prior year (may enter text, such as "Reopener")			

Negotiations Not Settled

3. Cost of a one percent increase in salary and statutory benefits

179,000

4. Amount included for any tentative salary increases

	Budget Year (2007-08)	1st Subsequent Year (2008-09)	2nd Subsequent Year (2009-10)
	0	0	0

Management/Supervisor/Confidential Health and Welfare (H&W) Benefits

- Are costs of H&W benefit changes included in the budget and MYPs?
- Total cost of H&W benefits
- Percent of H&W cost paid by employer
- Percent projected change in H&W cost over prior year

	Budget Year (2007-08)	1st Subsequent Year (2008-09)	2nd Subsequent Year (2009-10)
	No	No	No
	988,583	1,019,756	1,049,729
	74%	74%	74%
	5.5%	4.8%	4.8%

Management/Supervisor/Confidential Other Benefits (mileage, bonuses, etc.)

- Are costs of other benefits included in the budget and MYPs?
- Total cost of other benefits
- Percent change in cost of other benefits over prior year

	Budget Year (2007-08)	1st Subsequent Year (2008-09)	2nd Subsequent Year (2009-10)
	No	No	No
	52,019	30,173	30,173
	5.5%	3.0%	3.0%

ADDITIONAL FISCAL INDICATORS

DATA ENTRY: Click the appropriate Yes or No button for items A1 through A9 except item A3, which is automatically completed based on data in Criterion 2.

- A1. Do cash flow projections show that the district will end the budget year with a negative cash balance in the general fund?

- A2. Is the system of personnel position control independent from the payroll system?

- A3. Is enrollment decreasing in both the prior and budget years? (Data from the enrollment budget column of Criterion 2A are used to determine Yes or No)

- A4. Are new charter schools operating in district boundaries that impact the district's enrollment, either in the prior or budget year?

- A5. Has the district entered into a bargaining agreement where any of the budget or subsequent years of the agreement would result in salary increases that are expected to exceed the projected state cost-of-living adjustment?

- A6. Does the district provide uncapped (100% employer paid) health benefits for current or retired employees?

- A7. Is the district's financial system independent of the county office system?

- A8. Does the district have any reports that indicate fiscal distress pursuant to Education Code Section 42127.6(a)? (If Yes, provide copies to the county office of education)

- A9. Have there been personnel changes in the superintendent or chief business official positions within the last 12 months?

When providing comments for additional fiscal indicators, please include the item number applicable to each comment.

Comments:
(optional)

End of School District Budget Criteria and Standards Review

SACS2007 Financial Reporting Software - 2007.1.0
6/8/2007 3:19:54 PM

30-66621-0000000

July 1 Budget (Single Adoption)
2006-07 Estimated Actuals
Technical Review Checks

Orange Unified

Orange County

Following is a chart of the various types of technical review checks and related requirements:

- F - Fatal (Data must be corrected; an explanation is not allowed)
- W/WC - Warning/Warning with Calculation (If data are not correct, correct the data; if data are correct an explanation is required)
- O - Informational (If data are not correct, correct the data; if data are correct an explanation is optional, but encouraged)

IMPORT CHECKS

CHECKFUND - (F) - All FUND codes must be valid.	<u>PASSED</u>
CHECKRESOURCE - (W) - All RESOURCE codes must be valid.	<u>PASSED</u>
CHECKGOAL - (F) - All GOAL codes must be valid.	<u>PASSED</u>
CHECKFUNCTION - (F) - All FUNCTION codes must be valid.	<u>PASSED</u>
CHECKOBJECT - (F) - All OBJECT codes must be valid.	<u>PASSED</u>
CHK-FUNDxOBJECT - (F) - All FUND and OBJECT account code combinations must be valid.	<u>PASSED</u>
CHK-FUNDxRESOURCE - (W) - All FUND and RESOURCE account code combinations should be valid.	<u>PASSED</u>
CHK-FUNDxGOAL - (W) - All FUND and GOAL account code combinations should be valid.	<u>PASSED</u>
CHK-FUNDxFUNCTION-A - (W) - All FUND (funds 01 through 12, 19, 57, 62, and 73) and FUNCTION account code combinations should be valid.	<u>PASSED</u>
CHK-FUNDxFUNCTION-B - (F) - All FUND (all funds except for 01 through 12, 19, 57, 62, and 73) and FUNCTION account code combinations must be valid.	<u>PASSED</u>
CHK-RESOURCExOBJECTA - (W) - All RESOURCE and OBJECT (objects 8000 through 9999, except for 8998, 9791, 9793, and 9795) account code combinations should be valid.	<u>PASSED</u>
CHK-RESOURCExOBJECTB - (O) - All RESOURCE and OBJECT (objects 9791, 9793, and 9795) account code combinations should be valid.	<u>PASSED</u>
CHK-RESOURCExOB-8998 - (W) - Categorical Flexibility Transfers (Object 8998) are applicable only to resources specified in Section 12.40 of the annual Budget Act.	<u>PASSED</u>
CHK-FUNCTIONxOBJECT - (F) - All FUNCTION and OBJECT account code combinations must be valid.	<u>PASSED</u>
CHK-GOALxFUNCTION-A - (F) - All GOAL and FUNCTION (functions 1000-1999 and	

4000-5999, objects 1000-7999) account code combinations must be valid. PASSED

CHK-GOALxFUNCTION-B - (F) - General administration costs (functions 7200-7999, except 7210) must be direct-charged to an Undistributed, Nonagency, or County Services to Districts goal (Goal 0000, 7100-7199, or 8600-8699). PASSED

GEN-ADMIN-RESOURCE - (W) - General administration costs (functions 7200-7999, except 7210) have been direct-charged to a restricted resource (resources 2000-9999). General administration costs that are agency-wide, with rare exceptions, should be charged to unrestricted resources (resources 0000-1999). Administration costs charged to a restricted resource are generally program administration and should be coded to an instructional function, such as Function 2100, 2150, or 2420. The following costs should be reviewed and corrected if they are charged to an incorrect resource or function. (NOTE: Beginning 2007-08, general administration costs charged to restricted resources will be excluded from the indirect cost pool.) EXCEPTION

ACCOUNT						
FD - RS -PY-	GO - FN - OB	RESOURCE	FUNCTION		VALUE	
01-7394-0-0000-7200-5600		7394	7200		214,549.00	
Explanation:These are the indirect costs at the LEA approved rate for the Targeted Instructional Improvement Block Grant.						
01-7394-0-0000-7700-2300		7394	7700		88,994.00	
Explanation:These costs are the portion of the Targeted Instructional Improvement Block Grant assigned to the Educational Technology Program that supports districtwide information systems.						
01-7394-0-0000-7700-2400		7394	7700		492,055.00	
01-7394-0-0000-7700-3202		7394	7700		70,599.00	
01-7394-0-0000-7700-3302		7394	7700		43,254.00	
01-7394-0-0000-7700-3402		7394	7700		59,784.00	
01-7394-0-0000-7700-3502		7394	7700		291.00	
01-7394-0-0000-7700-3602		7394	7700		13,544.00	
01-7394-0-0000-7700-3702		7394	7700		2,722.00	
01-7394-0-0000-7700-3802		7394	7700		22,077.00	
01-7394-0-0000-7700-4300		7394	7700		33,200.00	
01-7394-0-0000-7700-4400		7394	7700		24,766.00	
01-7394-0-0000-7700-5200		7394	7700		8,782.00	
01-7394-0-0000-7700-5600		7394	7700		56,598.00	
01-7394-0-0000-7700-5800		7394	7700		127,316.00	
01-7394-0-0000-7700-5900		7394	7700		138,509.00	
01-7810-0-0000-7200-5800		7810	7200		6,000.00	
Explanation:SB 352 Chief Business Officials Training Program						

SPECIAL-ED-GOAL - (F) - Special Education revenue and expenditure transactions (resources 3300-3405, 6500-6540, and 7240, objects 1000-8999) must be coded to a Special Education 5000 goal or to Goal 7110, Nonagency-Educational. PASSED

PY-EFB=CY-BFB - (F) - Prior year ending fund balance (preloaded from last year's unaudited actuals submission) must equal current year beginning fund balance (Object 9791). PASSED

PY-EFB=CY-BFB-RES - (F) - Prior year ending balance (preloaded from last year's unaudited actuals submission) must equal current year beginning balance (Object 9791), by fund and resource. PASSED

GENERAL LEDGER CHECKS

INTERFD-DIR-COST - (F) - Transfers of Direct Costs - Interfund (Object 5750) must net to zero for all funds. PASSED

INTERFD-INDIRECT - (F) - Transfers of Indirect Costs - Interfund (Object 7350) must net to zero for all funds. PASSED

INTERFD-DIR-SUPP - (F) - Transfers of Direct Support Costs - Interfund (Object 7380) must net to zero for all funds. PASSED

INTERFD-INDIRECT-FN - (F) - Transfers of Indirect Costs - Interfund (Object 7350) must net to zero by function. PASSED

INTERFD-DIR-SUPP-FN - (F) - Transfers of Direct Support Costs - Interfund (Object 7380) must net to zero by function. PASSED

INTERFD-IN-OUT - (F) - Interfund Transfers In (objects 8910-8929) must equal Interfund Transfers Out (objects 7610-7629). PASSED

DUE-FROM=DUE-TO - (F) - Due from Other Funds (Object 9310) must equal Due to Other Funds (Object 9610). PASSED

PERS-REDUCTION - (F) - PERS Reduction Transfer (Object 8092) in the General Fund must equal PERS Reduction, certificated and classified positions (objects 3801-3802) in all funds. PASSED

RL-TRANSFER - (F) - Revenue Limit Transfers (objects 8091 and 8099) must net to zero, individually. PASSED

INTRA-FD-DIR-COST - (F) - Transfers of Direct Costs (Object 5710) must net to zero by fund. PASSED

INTRA-FD-INDIRECT - (F) - Transfers of Indirect Costs (Object 7310) must net to zero by fund. PASSED

INTRA-FD-DIR-SUPP - (F) - Transfers of Direct Support Costs (Object 7370) must net to zero by fund. PASSED

INTRA-FD-INDIRECT-FN - (F) - Transfers of Indirect Costs (Object 7310) must net to zero by function. PASSED

INTRA-FD-DIR-SUPP-FN - (F) - Transfers of Direct Support Costs (Object 7370) must net to zero by function. PASSED

CONTRIB-UNREST-REV - (F) - Contributions from Unrestricted Revenues (Object 8980) must net to zero by fund. PASSED

CONTRIB-RESTR-REV - (F) - Contributions from Restricted Revenues (Object 8990) must net to zero by fund. PASSED

BLOCK-GRANT-TRANSFER - (F) - Categorical Education Block Grant Transfers (Object 8995) must net to zero by fund. PASSED

CAT-TRANSFER - (F) - Categorical Flexibility Transfers (Object 8998) must net to zero by fund. PASSED

LOTTERY-CONTRIB - (F) - There should be no contributions (objects 8980-8999) to the lottery (resources 1100 and 6300) or from the Lottery: Instructional

Materials (Resource 6300).

PASSED

PASS-THRU-REV=EXP - (W) - Pass-through revenues from all sources (objects 8287, 8587, and 8697) should equal transfers of pass-through revenues to other agencies (objects 7211 through 7213, plus 7299 for resources 3327 and 3328), by resource.

PASSED

EXCESS-DESIGNATIONSA - (F) - Legally restricted and other designation amounts reported in objects 9740 through 9780 should not create a negative undesignated/unappropriated balance (Object 9790) by fund and resource (for all funds except Fund 67).

PASSED

EXCESS-DESIGNATIONSB - (W) - Legally restricted and other designation amounts reported in Fund 67, Self-Insurance Fund, objects 9740 through 9780, with rare exceptions should not create a negative undesignated/unappropriated balance (Object 9790) by resource.

PASSED

EFB-POSITIVE - (W) - All ending fund balances (Object 979Z) should be positive by resource, by fund.

PASSED

OBJ-POSITIVE - (W) - The following objects have a negative balance by resource, by fund:

EXCEPTION

FUND	RESOURCE	OBJECT	VALUE
01	6500	7222	-631,842.00

Explanation: Expenditures have been decreased to reflect current information including reductions in prior year cost estimates.

12	5080	4300	-779.00
----	------	------	---------

Explanation: Expenditures have been decreased to reflect current information including reductions in prior year cost estimates.

12	5080	8290	-779.00
----	------	------	---------

Explanation: Revenues have been decreased to include current information including reductions in prior year revenue estimates.

REV-POSITIVE - (W) - In the following resources, total revenues exclusive of contributions (objects 8000-8979) are negative, by fund:

EXCEPTION

FUND	RESOURCE	VALUE
12	5080	-779.00

Explanation: Same explanation as above

EXP-POSITIVE - (W) - The following expenditure functions have a negative balance by resource, by fund. (NOTE: Functions, including CDE-defined optional functions, are checked individually, except functions 7200-7600 are combined.)

EXCEPTION

FUND	RESOURCE	FUNCTION	VALUE
12	5080	1000	-779.00

Explanation: Same explanation as above

AR-AP-POSITIVE - (W) - Accounts Receivable (Object 9200), Due from Other Funds (Object 9310), Accounts Payable (Object 9500), and Due to Other Funds (Object 9610) should have a positive balance by resource, by fund.

PASSED

CEFB-POSITIVE - (F) - Components of Ending Fund Balance (objects 9700-9789) must be positive individually by resource, by fund. PASSED

SUPPLEMENTAL CHECKS

RL-CALC - (F) - Revenue Limit Sources (objects 8010-8089) minus Charter Schools General Purpose Entitlement - State Aid (Object 8015) minus Revenue Limit State Aid - Prior Years (Object 8019) should agree with Property Taxes (ID 0117), plus Miscellaneous Funds (ID 0078), plus Community Redevelopment Funds (ID 0079), plus Total State Aid Portion of Revenue Limit (Line 42) in Form RL. PASSED

RL-STATE-AID - (F) - RL State Aid-Current Year (Object 8011) should agree with Total State Aid Portion of Revenue Limit calculated in Form RL (Line 42). PASSED

RL-LOCAL-REVENUES - (F) - The sum of RL Local Revenues (objects 8020-8089) should agree with the sum of Local Revenues (IDs 0117, 0078, and 0079) in Form RL. PASSED

ADA-RL-COMPARISON - (F) - In Form A, Total Revenue Limit - K-12 ADA (Line 10) minus ADA from Necessary Small Schools (Line 11) plus ADA for Block Grant Funded Charters Sponsored by a Unified District, pupils residing in the Unified District (Line 24a), plus ADA for Revenue Limit Funded Charters (Line 25) should agree with the ADA reported in Form RL, Line 5b. PASSED

RL-PERS-REDUCTION - (WC) - The PERS Reduction Transfer (Object 8092) should equal PERS Reduction (ID 0195) minus PERS Safety Adjustment (ID 0205) in Form RL (unless Line 31 is zero). PASSED

ASSET-ACCUM-DEPR-NEG - (F) - In Form ASSET, accumulated depreciation for governmental and business-type activities must be zero or negative. PASSED

DEBT-ACTIVITY - (O) - If long-term debt exists, there should be activity entered in the Schedule of Long-Term Liabilities (Form DEBT) for each type of debt. PASSED

DEBT-POSITIVE - (F) - In Form DEBT, long-term liability ending balances must be positive. PASSED

EXPORT CHECKS

FORM01-PROVIDE - (F) - Form 01 (Form 01I) must be opened and saved. PASSED

RL-SUPP-PROVIDE - (F) - Revenue Limit supplemental data (Form RL) must be provided. PASSED

ADA-PROVIDE - (F) - Average Daily Attendance data (Form A) must be provided. PASSED

CHK-UNBALANCED-DATA - (W) - Unbalanced or incomplete data in any of the forms should be corrected before an official export is completed. PASSED

CHK-DEPENDENCY - (F) - If data have changed that affect other forms, the affected forms must be opened and saved. PASSED

Checks Completed.

SACS2007 Financial Reporting Software - 2007.1.0
6/8/2007 4:14:54 PM

30-66621-0000000

July 1 Budget (Single Adoption)
2007-08 Budget
Technical Review Checks

Orange Unified

Orange County

Following is a chart of the various types of technical review checks and related requirements:

- F - Fatal (Data must be corrected; an explanation is not allowed)
- W/WC - Warning/Warning with Calculation (If data are not correct, correct the data; if data are correct an explanation is required)
- O - Informational (If data are not correct, correct the data; if data are correct an explanation is optional, but encouraged)

IMPORT CHECKS

CHECKFUND - (F) - All FUND codes must be valid.	<u>PASSED</u>
CHECKRESOURCE - (W) - All RESOURCE codes must be valid.	<u>PASSED</u>
CHECKGOAL - (F) - All GOAL codes must be valid.	<u>PASSED</u>
CHECKFUNCTION - (F) - All FUNCTION codes must be valid.	<u>PASSED</u>
CHECKOBJECT - (F) - All OBJECT codes must be valid.	<u>PASSED</u>
CHK-FUNDxOBJECT - (F) - All FUND and OBJECT account code combinations must be valid.	<u>PASSED</u>
CHK-FUNDxRESOURCE - (W) - All FUND and RESOURCE account code combinations should be valid.	<u>PASSED</u>
CHK-FUNDxGOAL - (W) - All FUND and GOAL account code combinations should be valid.	<u>PASSED</u>
CHK-FUNDxFUNCTION-A - (W) - All FUND (funds 01 through 12, 19, 57, 62, and 73) and FUNCTION account code combinations should be valid.	<u>PASSED</u>
CHK-FUNDxFUNCTION-B - (F) - All FUND (all funds except for 01 through 12, 19, 57, 62, and 73) and FUNCTION account code combinations must be valid.	<u>PASSED</u>
CHK-RESOURCExOBJECTA - (W) - All RESOURCE and OBJECT (objects 8000 through 9999, except for 8998, 9791, 9793, and 9795) account code combinations should be valid.	<u>PASSED</u>
CHK-RESOURCExOBJECTB - (O) - All RESOURCE and OBJECT (objects 9791, 9793, and 9795) account code combinations should be valid.	<u>PASSED</u>
CHK-RESOURCExOB-8998 - (W) - Categorical Flexibility Transfers (Object 8998) are applicable only to resources specified in Section 12.40 of the annual Budget Act.	<u>PASSED</u>
CHK-FUNCTIONxOBJECT - (F) - All FUNCTION and OBJECT account code combinations must be valid.	<u>PASSED</u>
CHK-GOALxFUNCTION-A - (F) - All GOAL and FUNCTION (functions 1000-1999 and	

4000-5999, objects 1000-7999) account code combinations must be valid. PASSED

CHK-GOALxFUNCTION-B - (F) - General administration costs (functions 7200-7999, except 7210) must be direct-charged to an Undistributed, Nonagency, or County Services to Districts goal (Goal 0000, 7100-7199, or 8600-8699). PASSED

GEN-ADMIN-RESOURCE - (W) - General administration costs (functions 7200-7999, except 7210) have been direct-charged to a restricted resource (resources 2000-9999). General administration costs that are agency-wide, with rare exceptions, should be charged to unrestricted resources (resources 0000-1999). Administration costs charged to a restricted resource are generally program administration and should be coded to an instructional function, such as Function 2100, 2150, or 2420. The following costs should be reviewed and corrected if they are charged to an incorrect resource or function. (NOTE: Beginning 2007-08, general administration costs charged to restricted resources will be excluded from the indirect cost pool.) EXCEPTION

ACCOUNT				
FD - RS -PY-	GO - FN - OB	RESOURCE	FUNCTION	VALUE
01-7394-0-0000-	7200-5600	7394	7200	252,798.00
Explanation:These are the indirect costs at the LEA approved rate for the Targeted Instructional Improvement Block Grant.				
01-7394-0-0000-	7700-2300	7394	7700	91,679.00
Explanation:These costs are the portion of the Targeted Instructional Improvement Block Grant assigned to the Educational Technology program that support districtwide information systems.				
01-7394-0-0000-	7700-2400	7394	7700	545,021.00
01-7394-0-0000-	7700-3202	7394	7700	90,360.00
01-7394-0-0000-	7700-3302	7394	7700	48,708.00
01-7394-0-0000-	7700-3402	7394	7700	65,698.00
01-7394-0-0000-	7700-3502	7394	7700	318.00
01-7394-0-0000-	7700-3602	7394	7700	10,442.00
01-7394-0-0000-	7700-3702	7394	7700	7,322.00
01-7394-0-0000-	7700-3802	7394	7700	24,299.00
01-7394-0-0000-	7700-4300	7394	7700	33,600.00
01-7394-0-0000-	7700-4400	7394	7700	25,000.00
01-7394-0-0000-	7700-5200	7394	7700	9,500.00
01-7394-0-0000-	7700-5600	7394	7700	57,200.00
01-7394-0-0000-	7700-5800	7394	7700	144,000.00
01-7394-0-0000-	7700-5900	7394	7700	134,000.00

SPECIAL-ED-GOAL - (F) - Special Education revenue and expenditure transactions (resources 3300-3405, 6500-6540, and 7240, objects 1000-8999) must be coded to a Special Education 5000 goal or to Goal 7110, Nonagency-Educational. PASSED

GENERAL LEDGER CHECKS

INTERFD-DIR-COST - (F) - Transfers of Direct Costs - Interfund (Object 5750) must net to zero for all funds. PASSED

INTERFD-INDIRECT - (F) - Transfers of Indirect Costs - Interfund (Object 7350) must net to zero for all funds. PASSED

INTERFD-DIR-SUPP - (F) - Transfers of Direct Support Costs - Interfund (Object 7380) must net to zero for all funds. PASSED

INTERFD-INDIRECT-FN - (F) - Transfers of Indirect Costs - Interfund (Object

7350) must net to zero by function. PASSED

INTERFD-DIR-SUPP-FN - (F) - Transfers of Direct Support Costs - Interfund (Object 7380) must net to zero by function. PASSED

INTERFD-IN-OUT - (F) - Interfund Transfers In (objects 8910-8929) must equal Interfund Transfers Out (objects 7610-7629). PASSED

PERS-REDUCTION - (F) - PERS Reduction Transfer (Object 8092) in the General Fund must equal PERS Reduction, certificated and classified positions (objects 3801-3802) in all funds. PASSED

RL-TRANSFER - (F) - Revenue Limit Transfers (objects 8091 and 8099) must net to zero, individually. PASSED

INTRA FD-DIR-COST - (F) - Transfers of Direct Costs (Object 5710) must net to zero by fund. PASSED

INTRA FD-INDIRECT - (F) - Transfers of Indirect Costs (Object 7310) must net to zero by fund. PASSED

INTRA FD-DIR-SUPP - (F) - Transfers of Direct Support Costs (Object 7370) must net to zero by fund. PASSED

INTRA FD-INDIRECT-FN - (F) - Transfers of Indirect Costs (Object 7310) must net to zero by function. PASSED

INTRA FD-DIR-SUPP-FN - (F) - Transfers of Direct Support Costs (Object 7370) must net to zero by function. PASSED

CONTRIB-UNREST-REV - (F) - Contributions from Unrestricted Revenues (Object 8980) must net to zero by fund. PASSED

CONTRIB-RESTR-REV - (F) - Contributions from Restricted Revenues (Object 8990) must net to zero by fund. PASSED

BLOCK-GRANT-TRANSFER - (F) - Categorical Education Block Grant Transfers (Object 8995) must net to zero by fund. PASSED

CAT-TRANSFER - (F) - Categorical Flexibility Transfers (Object 8998) must net to zero by fund. PASSED

LOTTERY-CONTRIB - (F) - There should be no contributions (objects 8980-8999) to the lottery (resources 1100 and 6300) or from the Lottery: Instructional Materials (Resource 6300). PASSED

PASS-THRU-REV=EXP - (W) - Pass-through revenues from all sources (objects 8287, 8587, and 8697) should equal transfers of pass-through revenues to other agencies (objects 7211 through 7213, plus 7299 for resources 3327 and 3328), by resource. PASSED

EXCESS-DESIGNATIONSA - (F) - Legally restricted and other designation amounts reported in objects 9740 through 9780 should not create a negative undesignated/unappropriated balance (Object 9790) by fund and resource (for all funds except Fund 67). PASSED

EXCESS-DESIGNATIONSB - (W) - Legally restricted and other designation amounts reported in Fund 67, Self-Insurance Fund, objects 9740 through 9780, with rare exceptions should not create a negative undesignated/unappropriated balance

(Object 9790) by resource. PASSED

EFB-POSITIVE - (W) - All ending fund balances (Object 979Z) should be positive by resource, by fund. PASSED

OBJ-POSITIVE - (W) - All applicable objects should have a positive balance by resource, by fund. PASSED

REV-POSITIVE - (W) - Revenue amounts exclusive of contributions (objects 8000-8979) should be positive by resource, by fund. PASSED

EXP-POSITIVE - (W) - Expenditure amounts (objects 1000-7999) should be positive by function, resource, and fund. PASSED

CEFB-POSITIVE - (F) - Components of Ending Fund Balance (objects 9700-9789) must be positive individually by resource, by fund. PASSED

SUPPLEMENTAL CHECKS

RL-CALC - (F) - Revenue Limit Sources (objects 8010-8089) minus Charter Schools General Purpose Entitlement - State Aid (Object 8015) minus Revenue Limit State Aid - Prior Years (Object 8019) should agree with Property Taxes (ID 0117), plus Miscellaneous Funds (ID 0078), plus Community Redevelopment Funds (ID 0079), plus Total State Aid Portion of Revenue Limit (Line 42) in Form RL. PASSED

RL-STATE-AID - (F) - RL State Aid-Current Year (Object 8011) should agree with Total State Aid Portion of Revenue Limit calculated in Form RL (Line 42). PASSED

RL-LOCAL-REVENUES - (F) - The sum of RL Local Revenues (objects 8020-8089) should agree with the sum of Local Revenues (IDs 0117, 0078, and 0079) in Form RL. PASSED

ADA-RL-COMPARISON - (F) - In Form A, Total Revenue Limit - K-12 ADA (Line 10) minus ADA from Necessary Small Schools (Line 11) plus ADA for Block Grant Funded Charters Sponsored by a Unified District, pupils residing in the Unified District (Line 24a), plus ADA for Revenue Limit Funded Charters (Line 25) should agree with the ADA reported in Form RL, Line 5b. PASSED

RL-PERS-REDUCTION - (WC) - The PERS Reduction Transfer (Object 8092) should equal PERS Reduction (ID 0195) minus PERS Safety Adjustment (ID 0205) in Form RL (unless Line 31 is zero). PASSED

CS-EXPLANATIONS - (F) - Explanations must be provided in the Criteria and Standards Review (Form 01CS) for all criteria where the standard has not been met and for supplemental information items S1 through S6 where the status is Not Met or Yes. PASSED

CS-YES-NO - (F) - Supplemental information items and additional fiscal indicator items in the Criteria and Standards Review (Form 01CS) must be answered Yes or No, where applicable, for the form to be complete. PASSED

EXPORT CHECKS

FORM01-PROVIDE - (F) - Form 01 (Form 01I) must be opened and saved. PASSED

RL-SUPP-PROVIDE - (F) - Revenue Limit supplemental data (Form RL) must be provided. PASSED

BUDGET-CERT-PROVIDE - (F) - Budget Certification (Form CB) must be provided. PASSED

WK-COMP-CERT-PROVIDE - (F) - Workers' Compensation Certification (Form CC) must be provided. PASSED

ADA-PROVIDE - (F) - Average Daily Attendance data (Form A) must be provided. PASSED

CS-PROVIDE - (F) - The Criteria and Standards Review (Form 01CS) has been provided. PASSED

MYP-PROVIDE - (W) - A Multiyear Projection Worksheet must be provided with your Budget. (Note: LEAs may use a multiyear projection worksheet other than Form MYP, with approval of their reviewing agency, as long as it provides current year and at least two subsequent fiscal years, and separately projects unrestricted resources, restricted resources, and combined total resources.) PASSED

CHK-UNBALANCED-DATA - (W) - Unbalanced or incomplete data in any of the forms should be corrected before an official export is completed. PASSED

CHK-DEPENDENCY - (F) - If data have changed that affect other forms, the affected forms must be opened and saved. PASSED

Checks Completed.

VI

Glossary of Common School Finance Terms

GLOSSARY OF COMMON SCHOOL FINANCE TERMS

the last school month ending on or before December 31 of a school year. The Second Principal Apportionment ADA (called the P-2 ADA) is counted from July 1 through the last school month ending on or before April 15 of a school year. Annual ADA is based on the count from July 1 through June 30. The final recalculation of the apportionment is based on a school agency's P-2 ADA, except for adult education programs, regional occupational centers, and programs and nonpublic school funding, all of which use the annual count of ADA. Also, when a district has a very large influx of migrant students in the spring, a district may request the use of annual ADA in lieu of P-2 ADA.

Base Revenue Limit - See Revenue Limit.

Basic Aid - The California Constitution guarantees that each school district will receive a minimum amount of State aid, called "basic aid," equal to \$120 per ADA or \$2,400 per district, whichever is greater. "Basic aid school districts" are those eligible for the basic aid constitutional guarantee only, since all of the balance of the school districts' revenue limit is funded by local property taxes.

Benefit Assessment Districts - See Maintenance Assessment Districts.

Bonded Indebtedness - An obligation incurred by the sale of bonds for acquisition of school facilities or other capital expenditures. Since 1986, districts have been able to levy a local property tax to amortize bonded indebtedness, provided the taxes are approved by a two-thirds vote of the electorate.

Categorical Aid - Funds from the State or Federal Government granted to qualifying school agencies for specialized programs regulated and controlled by Federal or State law or regulation. Examples include programs for children with special needs, such as special education and Gifted and Talented Education (GATE); special programs, such as the School Improvement Program (SIP); or special purposes, such as transportation. Expenditure of most categorical aid is restricted to its particular purpose. The funds are granted to districts in addition to their revenue limits.

CBEDS (California Basic Education Data System) - The Statewide system of collecting enrollment, staffing and salary data from all school districts on an "Information Day" each October.

CBEST (The California Basic Education Skills Test) - Required of anyone seeking certification as a teacher. This test measures proficiency in reading, writing, and mathematics.

Certificated Personnel - School employees who hold positions for which a credential is required by the State - teachers, librarians, counselors, and most administrators.

Classified Personnel - School employees who hold positions that do not require a credential, like aides, custodians, clerical support, cafeteria workers, bus drivers, etc.

Class-Size Penalties - The penalties imposed on school districts that have classes in excess of certain maximum sizes. Class-size penalties result in a reduction in ADA which, in turn, results in a loss in revenue limit income (see Education Code Sections 41376 and 41378).

GLOSSARY OF COMMON SCHOOL FINANCE TERMS

ADA (Average Daily Attendance) - There are several kinds of attendance, and these are counted in different ways. For regular attendance, ADA is equal to the average number of pupils actually attending classes who are enrolled for at least the minimum school day. Up through 1997-98, ADA included excused absences; however, effective 1998-99, excused absences no longer count towards ADA. In classes for adults and ROC/P, one unit of ADA is credited for each 525 classroom hours. Attendance is counted every day of the school year and is reported to the California Department of Education three times a year.

AB 1200 - Reference to AB 1200 (Chapter 1213/1991) that imposed major fiscal accountability controls on school districts and county offices of education by establishing significant administrative hurdles and obligations for agency budgets and fiscal practices (see Education Code Sections 1240 et seq. and 42131 et seq.).

Accrual Basis Accounting - An accounting system where transactions are recorded when they have been reduced to a legal or contractual right or obligation to receive or pay out cash or other resources.

Ad Valorem Taxes - Taxes that are based on the value of property, such as the standard property tax. The only new taxes based on the value of property that are allowed today are those imposed with a two-thirds voter approval for capital facilities bonded indebtedness.

Apportionment - State aid given to a school district or county office of education. Apportionments are calculated three times for each school year: (1) the First Principal Apportionment (P-1) is calculated in February of the school year corresponding to the P-1 ADA (see Attendance Reports); (2) the Second Principal Apportionment (P-2) is

calculated in June corresponding to the P-2 ADA; and (3) the annual recalculation of the apportionment is made in February following the school year and is based on P-2 ADA (except for programs where the annual count of ADA is used).

Appropriation Bill - A bill before the Legislature authorizing the expenditure of public money and stipulating the amount, manner, and purpose for the expenditure items.

Appropriation For Contingencies - That portion of the current fiscal year's budget that is not appropriated for any specific purpose but is held subject to intra-budget transfer (i.e. transfer to other specific appropriation accounts as needed during the fiscal year).

Assessed Valuation or Assessed Value - The total value of property for taxation purposes within a school agency, as determined by State and county assessors. The "AV" of a school district will influence the total property tax income of a school district. The percentage growth in Statewide AV from one year to the next is an important ingredient in determining appropriations levels required from the State for fully funding district and county revenue limits, as well as for Proposition 98 calculations. Ever since Proposition 13, the assessed value of properties in California is adjusted to the true market value only at the time of new construction or transfer of ownership. For all other properties, the assessed value grows by a maximum of 2% a year, resulting in the assessed value of many properties being far less than their current market value.

Attendance Reports - Each school agency reports its attendance three times during a school year. The First Principal Apportionment ADA, called the P-1 ADA or the P-1 count, is counted from July 1 through

GLOSSARY OF COMMON SCHOOL FINANCE TERMS

Concurrently Enrolled - Pupils who are enrolled both in a regular program for at least the minimum school day and also in a regional occupational center or program (ROC/P) or class for adults. Such a student will generate both regular ADA for the time in the regular program plus concurrently enrolled ADA for the time in ROC/P or adult classes. By qualifying for both regular ADA and concurrently enrolled ADA, a student can generate more than one unit of ADA.

Consumer Price Index (CPI) - A measure of the cost-of-living for consumers compiled by the United States Bureau of Labor Statistics. Separate indices of inflation are calculated regularly for the United States, California, some regions within California, and selected cities. The CPI is one of several measures of inflation.

Cost-of-Living Adjustment (COLA) - An increase in funding for government programs, including revenue limits or categorical programs. Current law ties the COLA for most education programs to the annual percentage change in the "Implicit Price Deflator" for State and Local Governments - a government price index (see Education Code Section 42238.1).

Credentialed Teacher - One holding a credential to teach issued by the State Commission on Teacher Credentialing. A credential is issued to those who have successfully completed all college training and courses required by the State, graduated from an accredited college or university, met any other State requirements, and passed the California Basic Education Skills Test (CBEST).

Criteria and Standards - Local school agency budgets must meet State-adopted provisions of "criteria and standards." These provisions establish minimum fiscal standards, such as a minimum reserve level,

that school districts, county offices of education, and the State use to monitor fiscal solvency and accountability (see Education Code Sections 33127 et seq.).

Declining Enrollment Adjustment - A formula that cushions the drop in income in a district with a declining student population. Under current law, districts are funded for the higher of either current year or prior year ADA.

Deficit Factor - When an appropriation to the State School Fund for revenue limits - or for any specific categorical program - is insufficient to pay all claims for State aid, a deficit factor is applied to reduce the allocation of State aid to the amount appropriated.

Economic Impact Aid (EIA) - State categorical aid for districts with concentrations of children who are bilingual, transient, and/or from low-income families.

Encroachment - The expenditure of school districts' general purpose funds in support of a categorical program (i.e. the categorical expense encroaches into the district's general fund for support). Encroachment occurs in most districts and county offices that provide special education and transportation. Other encroachment is caused by deficit factors or local decisions to allocate general purpose funds to special purpose programs.

Encumbrances - Obligations in the form of purchase orders, contracts, salaries, and other commitments chargeable to an appropriation for which a part of the appropriation is reserved.

GLOSSARY OF COMMON SCHOOL FINANCE TERMS

Equalization Aid - The extra State aid provided in some years – such as 1996-97 – to a low-revenue district to increase its base-revenue limit toward the Statewide average.

ERAF (Education Revenue Augmentation Fund) – The fund used to collect the property taxes that are shifted from cities, the county, and special districts within each county, prior to their distribution to K-14 school agencies.

Fact-finding - The culmination of the Impasse Procedures (Article 9) of the State's collective bargaining law. A tripartite panel, with the chairperson appointed and paid for by PERB, considers several specifically enumerated facts and makes findings of fact and recommendations in terms of settlement to a negotiating agreement. Such recommendations are advisory only and may be adopted or rejected in whole or in part by the parties.

Forest Reserve Funds - 25% of funds received by a county from the United States Government from rentals of forest reserve lands are apportioned among the various districts in the county according to school population.

Full-Time Equivalent (FTE) - A count of full-time and part-time employees where part-time employees are reported as an appropriate fraction of a full-time position. This fraction is equal to the ratio of time expended in a part-time position to that of a full-time position.

Gann Spending Limit - A ceiling, or limit, on each year's appropriations of tax dollars by the State, cities, counties, school districts, and special districts. Proposition 4, an initiative passed in November 1979, added controls on appropriations in Article XIII B of

the California Constitution. Using 1978-79 as a base year, subsequent years' limits have been adjusted for: (1) an inflation increase equal to the change in the Consumer Price Index or per capita personal income, whichever is smaller; and (2) the change in population, which for school agencies is the change in ADA. Proposition 111, adopted in June 1990, amended the Gann limit inflation factor to be based only on the change in per capita personal income.

General Obligation Bonds - Bonds that are a "general obligation" of the government agency issuing them (i.e. their repayment is not tied to a selected revenue stream). Bond elections in a school district can be approved by a two-thirds vote of the electorate or by a vote of 55% of the electorate under Proposition 39. State bond measures require only a majority vote.

Gifted and Talented Education (GATE) - A program for students in grades 1 through 12 who have shown potential abilities of high performance, capability and needing differentiated or accelerated education. "Gifted child educational programs" are those special instructional programs, supportive services, unique educational materials, learning settings, and other services which differentiate, supplement, and support the regular educational program in meeting the needs of gifted students.

High Revenue Districts - Districts that have a revenue limit per ADA that is greater than the State average for the same type of district (elementary, high school, or unified). Many high-revenue districts were formerly called "high wealth" because their assessed value per ADA was significantly above the Statewide average.

Implicit Price Deflator - See Cost-of-Living Adjustment.

GLOSSARY OF COMMON SCHOOL FINANCE TERMS

Indirect Expense and Overhead - Those elements of indirect cost necessary to the operation of the district or in the performance of a service that are of such nature that the amount applicable to each accounting unit cannot be separately identified. Indirect costs are allocated to all programs in a school agency as a percentage of direct and allocated costs for each program.

Individualized Education Program (IEP) - A written agreement between a school agency and parents or guardians of a disabled child specifying an educational program tailored to the needs of the child, in accordance with Federal PL 94-142 regulations. An IEP team is comprised of a certified district employee who is qualified to supervise special education, the child's teacher, one or both parents, the child, if appropriate, and other individuals at the discretion of the parent or school. The IEP must include a statement of the child's present levels of educational performance, a statement of annual goals and short-term instructional objectives, a statement of the specific special education and related services to be provided to the child, the extent to which the child will participate in regular education programs, the projected dates for starting services, appropriate objective criteria, evaluation procedures, and schedules for determining, on at least an annual basis, whether the short-term instructional objectives are being achieved.

Least Restrictive Environment - Federal and State law requires that disabled students be placed in the least restrictive educational environment appropriate to their needs so that they can, to the extent appropriate, integrate, and be educated with non-disabled students.

Leveling Down - Lowering the revenue level of high-revenue districts to promote revenue equity among school districts.

Leveling Up - Raising the revenue level of low-revenue districts to promote revenue equity among school districts.

Mandated Costs - School district expenses that occur because of Federal or State laws, decisions of State or Federal courts, Federal or State administrative regulations. Costs that are mandated by State law or regulations must be reimbursed by the State, while costs mandated by Federal law, a Court or an initiative do not need to be reimbursed by the State (see SB 90, 1977).

Maintenance Assessment Districts - A methodology for local agencies, including school agencies, to charge property owners a fee for the benefit derived by the property as a result of local agency service improvements (see Lighting and Landscape Act of 1972, Section 22500 of the Street and Highways Code). Originally, school agencies were allowed to impose the "fee" by a vote of the local governing board only, by merely showing a benefit to each fee payer. Now, however, a school agency must hold an election before such a fee can be levied.

Maintenance Factor - See Proposition 98.

Miscellaneous Funds - Local revenues received from mineral royalties, bonuses, and other payments in lieu of taxes. Fifty percent of such revenues are used as an offset to State aid in the revenue limit formulas.

Necessary Small School - An elementary school with 96 or fewer ADA or high school with 286 or fewer ADA that meets the standards of being "necessary" (see Education Code Sections 42280 et seq.).

GLOSSARY OF COMMON SCHOOL FINANCE TERMS

Parcel Tax - A special tax that is a flat amount per parcel and not ad valorem based (not according to the value of the property). Parcel taxes must be approved by a two-thirds vote of the electorate (see Government Code Section 50079, et al.).

PERB (Public Employment Relations Board) - Five persons appointed by the Governor to regulate collective bargaining between school employers and employee organizations (see Government Code Sections 3541, et seq.).

Permissive Override Tax - Prior to Proposition 13, any of a number of local tax levies that were for specific purposes and that required only the permission of a school board to be levied. School agencies are no longer allowed to levy such taxes.

PERS (Public Employees' Retirement System) - State law requires that classified employees, their employer, and the State contribute to this retirement fund.

PL81-874 - A Federal program of "Impact Aid" that provides funds to school agencies that educate children whose families live and/or work on Federal property, such as military bases (also called "PL874").

PL94-142 - Federal law that mandates a "free and appropriate" education for all disabled children.

Prior Year's Taxes - Tax revenues that had been delinquent in a prior year and that are received in the current fiscal year. These revenues offset State aid in the current year in the revenue-limit formula.

Proposition 13 - An initiative amendment (passed in June, 1978) adding Article XIII A to the California Constitution. Under Proposition 13, tax rates on secured property are restricted to no more than 1% of full cash value. Proposition 13 also defined assessed value and required a two-thirds vote to increase existing taxes or levy new taxes.

Proposition 98 - An initiative adopted in 1988 and then amended by Proposition 111 in 1990. Proposition 98 contains three major provisions: (1) a minimum level of State funding for K-14 school agencies (unless suspended by the Legislature); (2) a formula for allocating any State tax revenues in excess of the State's Gann Limit; and (3) the requirement that a School Accountability Report Card be prepared for every school. The minimum funding base is set equal to the greater of the amount of State aid determined by two formulas, commonly called ATest 1@ and ATest 2@ - unless an alternative formula, known as "Test 3," applies.

"Test 1" - originally provided that K-14 school agencies shall receive at least 40.319% of State general fund tax revenues in each year, the same percentage as was appropriated for K-14 school agencies in 1986-87. Due to the shift in property taxes from local governments to K-14 agencies, the "Test 1" percentage has been reset at 34.559%.

"Test 2" - provides that K-14 school agencies shall receive at least the same amount of combined State aid and local tax dollars as was received in the prior year, adjusted for the Statewide growth in K-12 ADA and an inflation factor equal to the annual percentage change in per capita personal income.

GLOSSARY OF COMMON SCHOOL FINANCE TERMS

"Test 3" - only applies in years in which the annual percentage change in per capita State general fund tax revenues plus 1/2% is lower than the "Test 2" inflation factor (i.e. change in per capita personal income), and in this case, the "Test 2" inflation factor is reduced to the annual percentage change in per capita State general fund tax revenues plus 1/2%.

One provision of Proposition 98/111 applies whenever the minimum funding level is reduced due either to "Test 3" or the suspension of the minimum funding level by the Legislature and Governor. The "maintenance factor" is initially calculated as the amount of the funding reduction, and this amount grows each year by Statewide ADA growth and inflation. In subsequent years when State taxes grow quickly, this "maintenance factor" is restored by increasing the Proposition 98 minimum funding level until the funding base is fully restored.

Purchase Order - An encumbrance document that shows the vendor from whom a purchase is being made, what is being purchased by the school agency, the amount of the purchase, the fund from which the purchase is being made (e.g. general, building or bond fund), an accounting code to which the purchase shall be applied, and the signature or initial approval of the designed central office personnel responsible for approving the ordering of goods.

Reduction-in-Force (RIF) - The process whereby employment is terminated because of a need to reduce the staff rather than because of any performance inadequacies of the employee.

Reserves - Funds set aside in a budget to provide for estimated future expenditures or to offset future losses, for working capital, or for other purposes.

Revenue Limit - The amount of revenue that a district can collect annually for general purposes from local property taxes and State aid. The revenue limit is composed of a base revenue limit (a basic education amount per unit of ADA computed by formula each year from the previous year's base revenue limit) and any of the number of revenue-limit adjustments that are computed anew each year.

The total revenue limit of a school district is generally determined by multiplying the district's P-2 ADA times the base revenue limit, adding the applicable revenue limit adjustments and applying a deficit factor.

Revolving Cash Funds - A stated amount of money used primarily for emergency or small or sundry disbursements and reimbursed periodically through properly documented expenditures, which are summarized and charged to proper account classifications.

ROC/P (Regional Occupational Center or Program) - a vocational educational program for high school students and adults. A ROC/P may be operated by a single district, by a consortium of districts under a joint powers agreement (JPA), or by a county office of education for the districts within the county.

SB 90 - Reference to Senate Bill 90 (Chapter 1406/1972) that established the revenue limit system for funding school districts. The first revenue limit amount was determined by dividing the district's 1972-73 State and local income by that year's ADA. This per-ADA

GLOSSARY OF COMMON SCHOOL FINANCE TERMS

amount is the historical base for all subsequent revenue limit calculations.

SB 813 - Reference to Senate Bill 813 (Chapter 498/1983) that provided a series of education "reforms" in funding calculations. Longer day, longer year, mentor teachers and beginning teacher salary adjustments are a few of the programs implemented by this 1983 legislation.

Scope of Bargaining - The range of subjects that are negotiated between school agencies and employee organizations during the collective bargaining process. Scope includes matters relating to wages, hours, and working conditions as defined in the Government Code. PERB and the Courts are responsible for interpreting disputes about scope.

Secured Roll - That portion of the assessed value that is stationary (i.e. land and buildings). See also Unsecured Roll. The secured roll averages about 90% of the taxable property in a district.

Serrano Decision - In 1974, the California Superior Court in Los Angeles County ruled in the Serrano v. Priest case that school district revenues in California depended so heavily on local property taxes that students in districts with a low assessed value per pupil were denied an equal educational opportunity in violation of the "Equal Protection" clause of the California Constitution. This ruling established certain standards under which the school finance system would be constitutional and was upheld by the California Supreme Court in 1976. In 1983, the California Superior Court in Los Angeles County ruled that the system of school finance in effect at that time was in compliance with the earlier Court Order. The case was subsequently

appealed to the Appellate Court which upheld the Superior Court ruling. In March 1989, all of the plaintiffs in the case agreed to dismiss their appeals, thereby settling Serrano as a legal issue.

Slippage - Savings in State school fund appropriations that are the result of property tax revenues growing faster than a district's cost-of-living and enrollment growth. When property tax growth is greater than the growth in a district's total revenue limit, State aid to the district declines, creating a "slippage" in State expense.

Squeeze Formula - The formula used from 1973-74 through 1981-82 for the calculation of the annual inflation increase in the base revenue limit that provided smaller-than-average increases to high-revenue districts. This formula thus "squeezed" the revenues of high-revenue districts as a means of promoting revenue equalization. Effective 1983-84, the squeeze formula was eliminated and all districts of the same type now receive the same dollar inflation increase.

State Allocation Board (SAB) - The regulatory agency that controls most State-aided capital outlay and deferred maintenance projects and distributes funds for them.

State School Fund - Each year the State appropriates money to this fund, which is then used to make State aid payments to school districts. Section A of the State School Fund is for K-12 education and Section B is for community college education.

STRS - The State Teachers' Retirement System, which is funded by contributions from both certificated employees and their employing school agencies, as well as by direct payments by the State.

GLOSSARY OF COMMON SCHOOL FINANCE TERMS

Subventions - The term used to describe assistance or financial support, usually from higher governmental units to local governments or school agencies. State aid to school agencies is a State subvention.

Sunset - The termination of a categorical program. A schedule is in current law for the Legislature to consider the "sunset" of most State categorical programs. If a program sunsets under this schedule, the funding for the program shall continue but the specific laws and regulations shall no longer apply.

Supplemental Roll - An additional property tax assessment for properties that are sold or newly constructed that reflect a higher market value than on their prior lien date. By taxing this increase in assessed value immediately – rather than waiting until the next lien date – additional property taxes are generated.

Test 1/Test 2/Test 3 - See Proposition 98.

Unduplicated Count - The number of pupils receiving special education or special services under the Master Plan for Special Education on the census dates of December 1 and April 1. Even though a pupil may receive multiple services, each pupil is counted only once in the unduplicated count.

Title I - Federal financial assistance to districts to meet the special needs of educationally deprived children (i.e. children whose educational attainment is below the level appropriate for children of their age). Funding is to supplement services in reading, language arts, and mathematics to identified students.

Title II - Federal financial assistance for schools under the Education Consolidation and Improvement Act, 20 U.S.C. Sec. 3811 et seq., which consolidated the provisions of Titles II, III, IV, VI, VII, and part IX of the Elementary and Secondary Education Act of 1965. The law provides Federal grants to develop and implement a comprehensive and coordinated program to improve elementary and secondary instruction in basic skills of reading, math and language arts, as formerly authorized in Title II.

Unencumbered Balance - That portion of an appropriation or allotment not yet expended or obligated.

Unsecured Roll - That portion of assessed property that is movable (such as boats, planes, etc.).

Waivers - Permission from the State Board of Education or, in some cases, from the Superintendent of Public Instruction, to set aside the requirements of an Education Code provision upon the request of a school agency. Certain Education Code sections cannot be waived (see Education Code Section 33050).

VII

Notes

